

Neuro Instruments  
神经外科

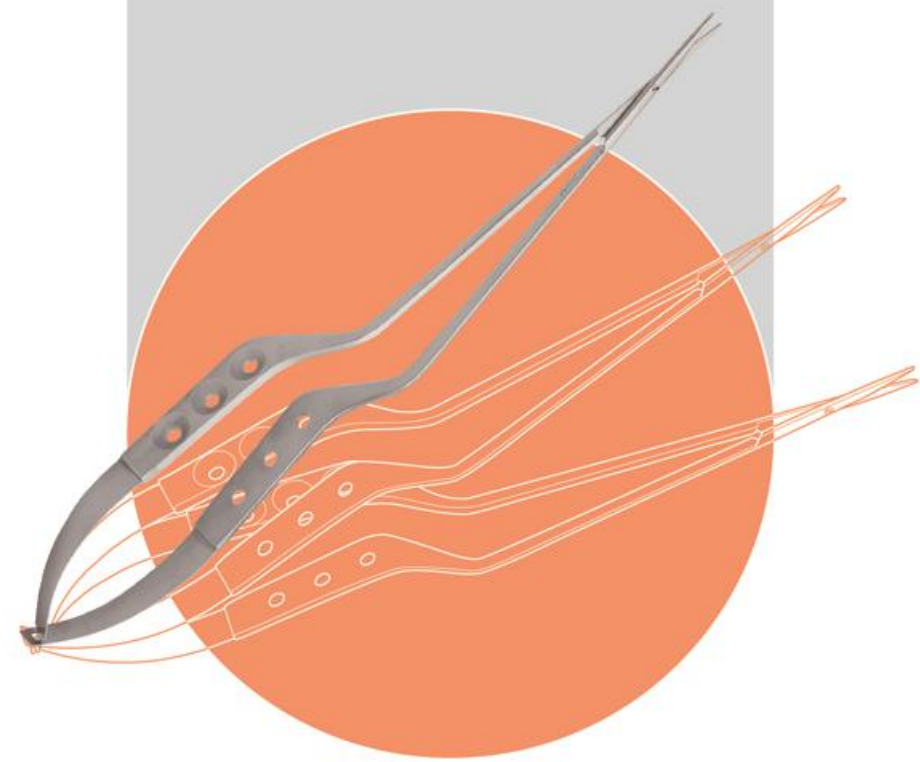

QUALITY  
OUR WAY TO SUCCESS



神经外科  
Neuro Instruments

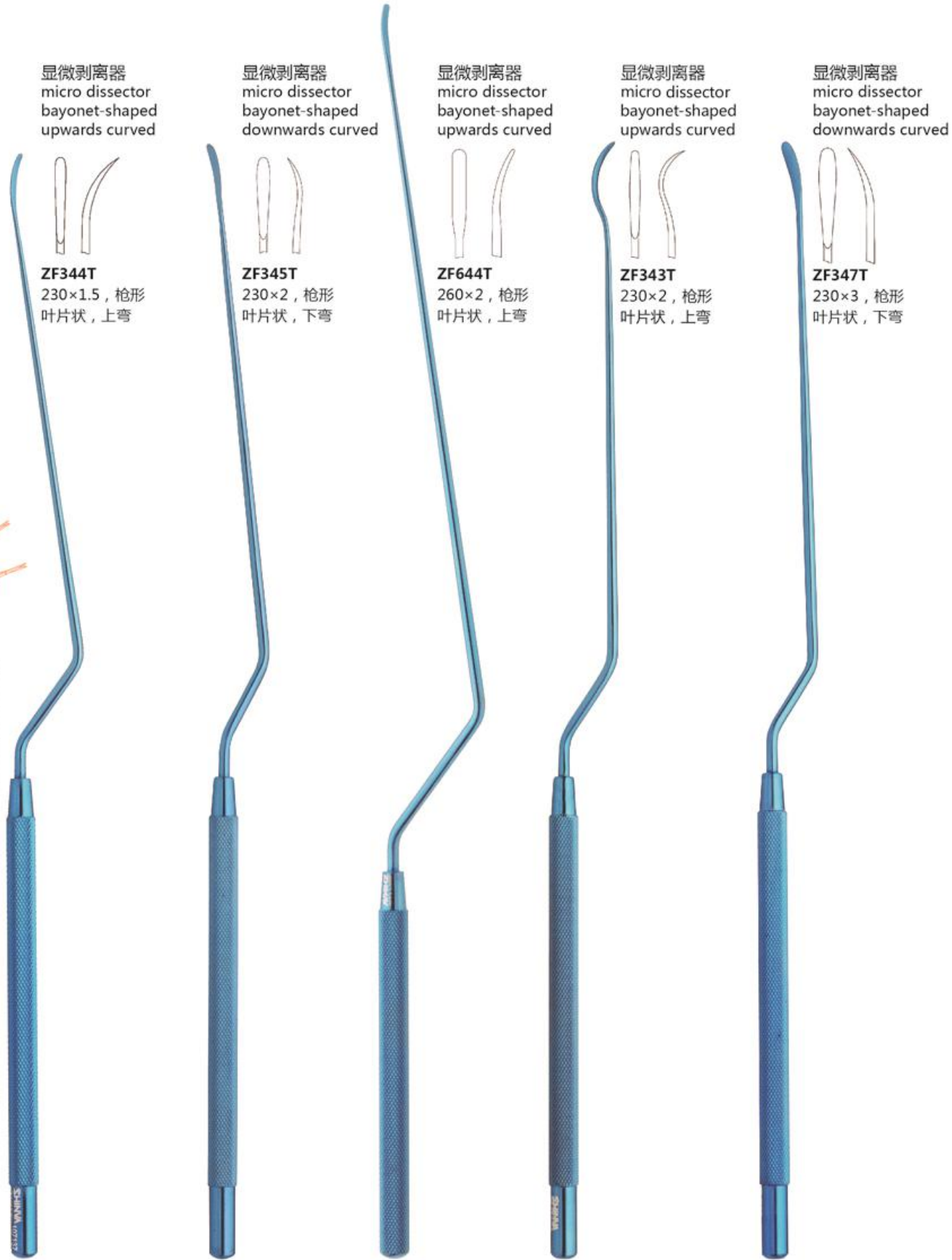

显微剥离器  
micro dissector  
bayonet-shaped  
upwards curved



**ZF344T**  
230×1.5, 枪形  
叶片状, 上弯

显微剥离器  
micro dissector  
bayonet-shaped  
downwards curved



**ZF345T**  
230×2, 枪形  
叶片状, 下弯

显微剥离器  
micro dissector  
bayonet-shaped  
upwards curved



**ZF644T**  
260×2, 枪形  
叶片状, 上弯

显微剥离器  
micro dissector  
bayonet-shaped  
upwards curved



**ZF343T**  
230×2, 枪形  
叶片状, 上弯

显微剥离器  
micro dissector  
bayonet-shaped  
downwards curved



**ZF347T**  
230×3, 枪形  
叶片状, 下弯

显微剥离器  
micro dissector  
bayonet-shaped  
downwards curved



**ZF353T**  
230×4.5, 枪形  
叶片状, 下弯

显微剥离器  
micro dissector  
bayonet-shaped  
upwards curved



**ZF1507T**  
240×1.5, 枪形  
叶片状, 上弯

**ZF1508T**  
240×2, 枪形  
叶片状, 上弯

**ZF1509T**  
240×2.5, 枪形  
叶片状, 上弯

**ZF1510T**  
240×3, 枪形  
叶片状, 上弯

显微剥离器  
pituitary enucleator  
left curved, blunt



**ZF368T**  
230×7钝  
枪状左弯

**ZF366T**  
230×7锐  
枪状左弯

显微剥离器  
pituitary enucleator  
right curved, sharp



**ZF367T**  
230×7锐  
枪状右弯

**ZF369T**  
230×7钝  
枪状右弯

显微剥离器  
raspatory  
ball pointed



**ZF1408T**  
210×Φ0.6  
直型, 球头

**ZF1410T**  
210×Φ1  
直型, 球头

**ZF429T**  
230×Φ1  
直型, 球头



神经外科  
Neuro Instruments

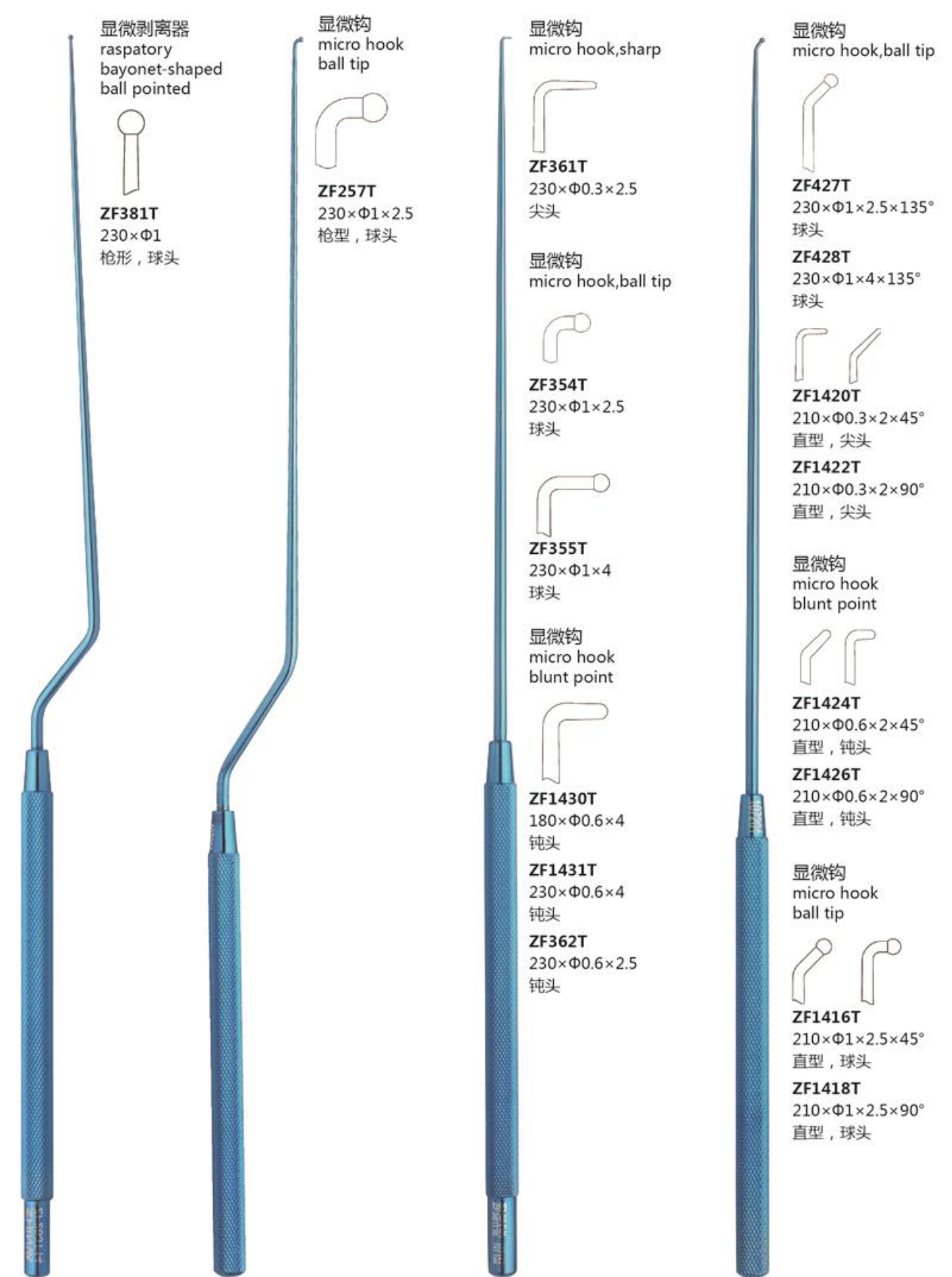
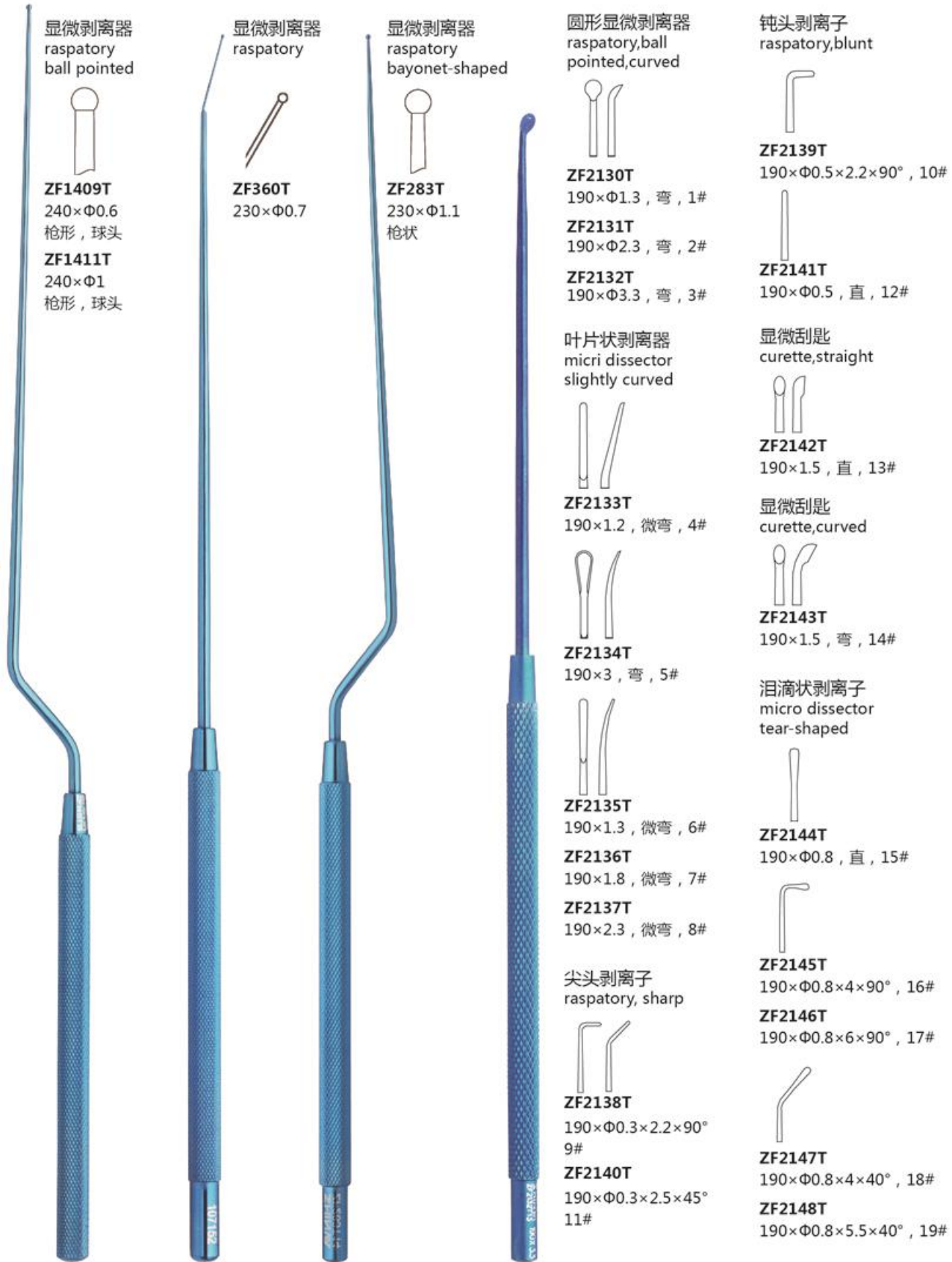



Neuro Instruments  
神经外科

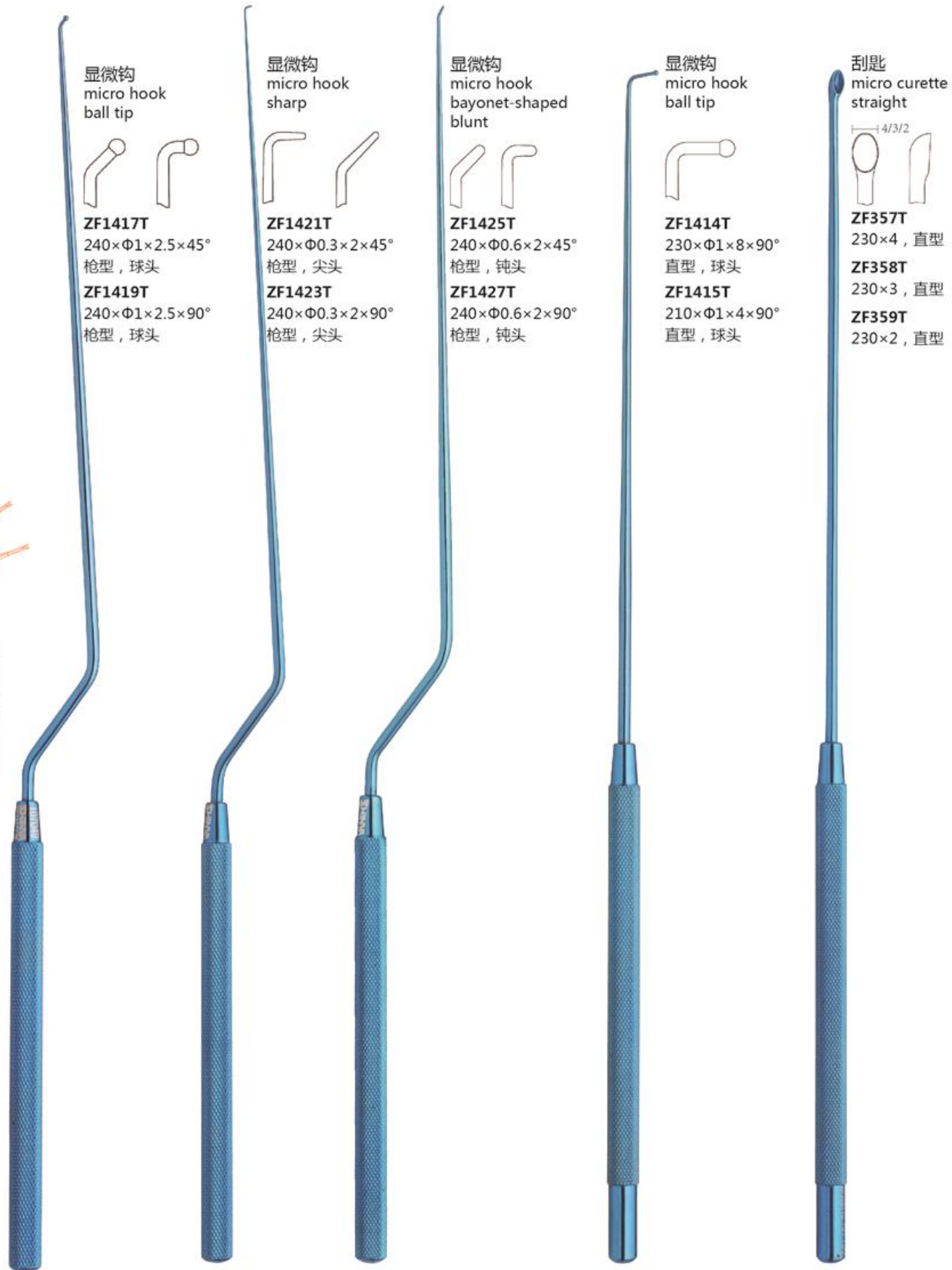

显微钩  
micro hook  
ball tip

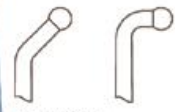

**ZF1417T**  
240×Φ1×2.5×45°  
枪型, 球头  
**ZF1419T**  
240×Φ1×2.5×90°  
枪型, 球头

显微钩  
micro hook  
sharp



**ZF1421T**  
240×Φ0.3×2×45°  
枪型, 尖头  
**ZF1423T**  
240×Φ0.3×2×90°  
枪型, 尖头

显微钩  
micro hook  
bayonet-shaped  
blunt

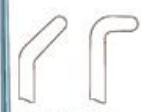

**ZF1425T**  
240×Φ0.6×2×45°  
枪型, 钝头  
**ZF1427T**  
240×Φ0.6×2×90°  
枪型, 钝头

显微钩  
micro hook  
ball tip



**ZF1414T**  
230×Φ1×8×90°  
直型, 球头  
**ZF1415T**  
210×Φ1×4×90°  
直型, 球头

刮匙  
micro curette  
straight

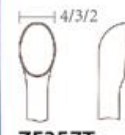

**ZF357T**  
230×4, 直型  
**ZF358T**  
230×3, 直型  
**ZF359T**  
230×2, 直型

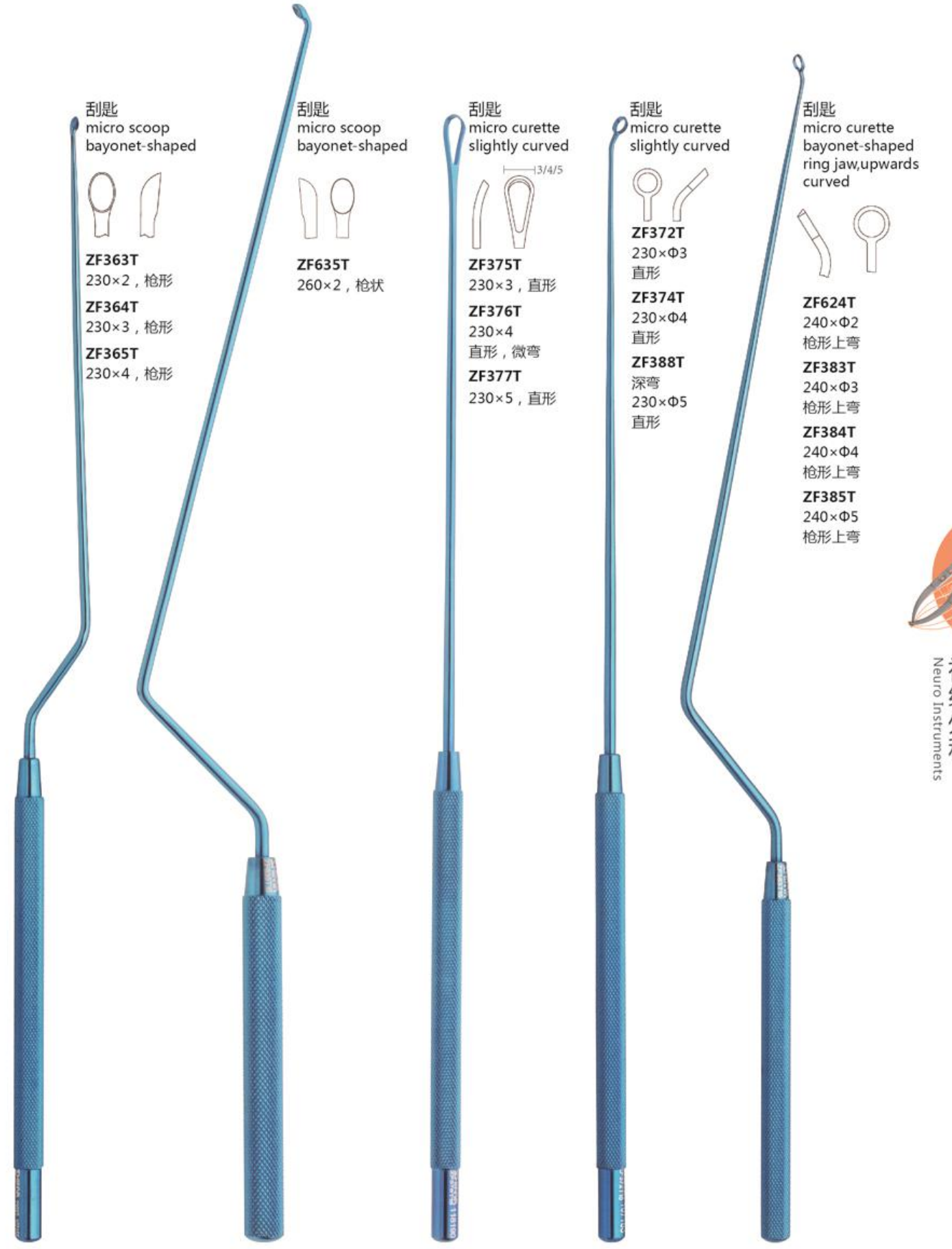

刮匙  
micro scoop  
bayonet-shaped



**ZF363T**  
230×2, 枪形  
**ZF364T**  
230×3, 枪形  
**ZF365T**  
230×4, 枪形

刮匙  
micro scoop  
bayonet-shaped

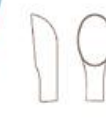

**ZF635T**  
260×2, 枪状

刮匙  
micro curette  
slightly curved

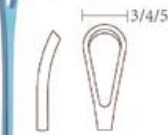

**ZF375T**  
230×3, 直形  
**ZF376T**  
230×4, 直形, 微弯  
**ZF377T**  
230×5, 直形

刮匙  
micro curette  
slightly curved



**ZF372T**  
230×Φ3  
直形  
**ZF374T**  
230×Φ4  
直形  
**ZF388T**  
深弯  
230×Φ5  
直形

刮匙  
micro curette  
bayonet-shaped  
ring jaw, upwards  
curved

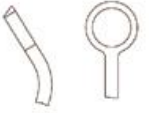

**ZF624T**  
240×Φ2  
枪形上弯  
**ZF383T**  
240×Φ3  
枪形上弯  
**ZF384T**  
240×Φ4  
枪形上弯  
**ZF385T**  
240×Φ5  
枪形上弯



Neuro Instruments  
神经外科

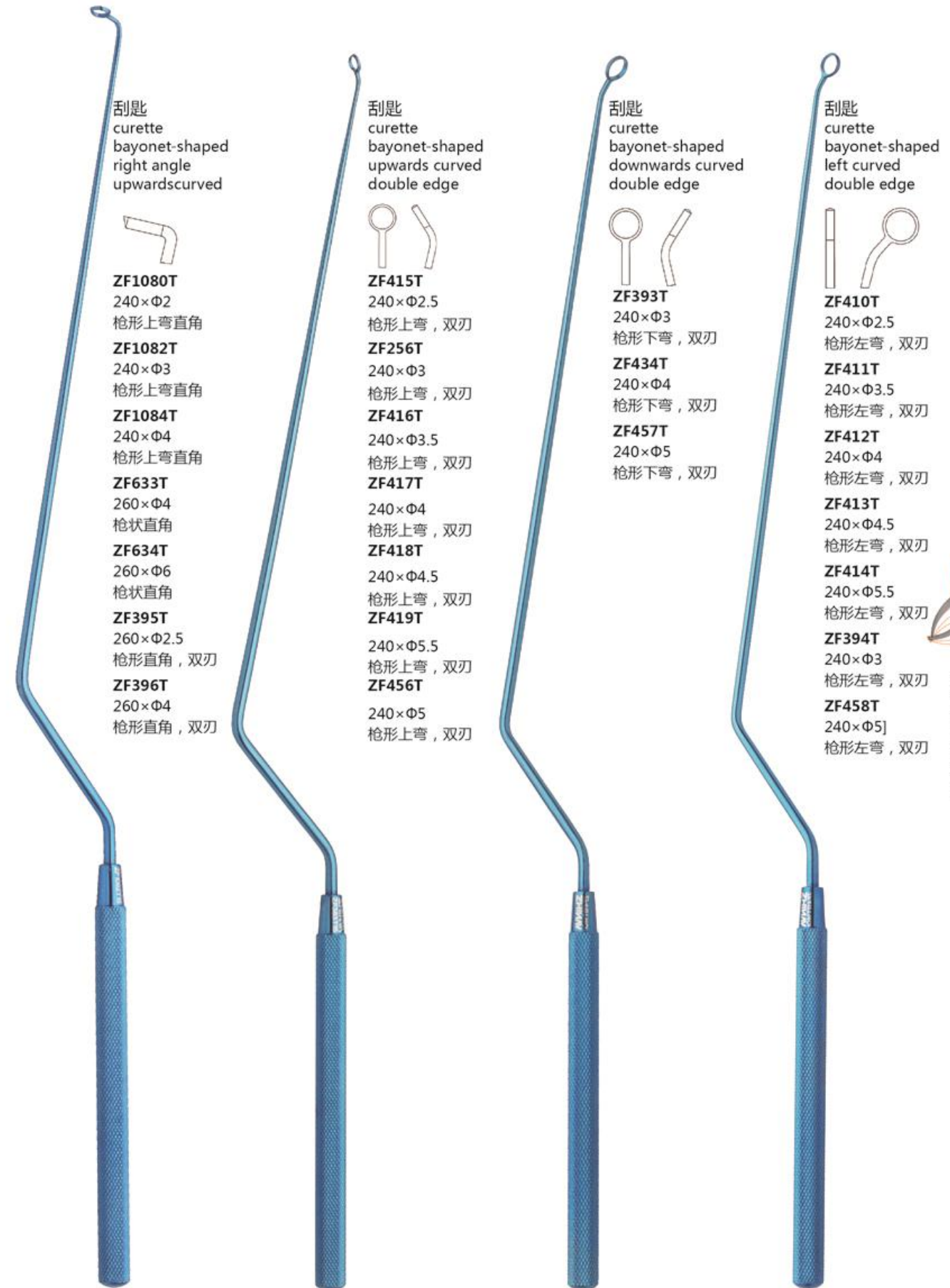
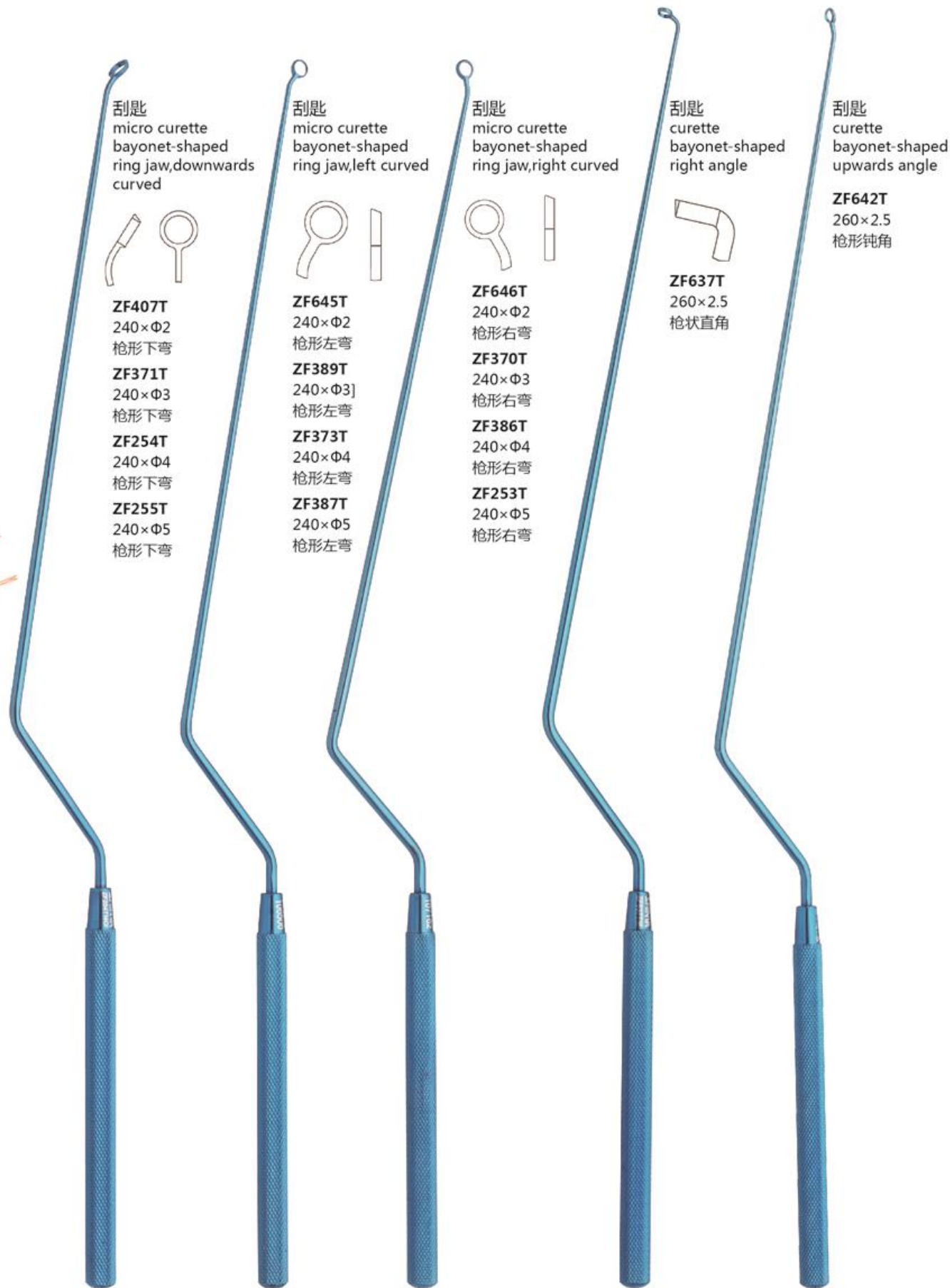

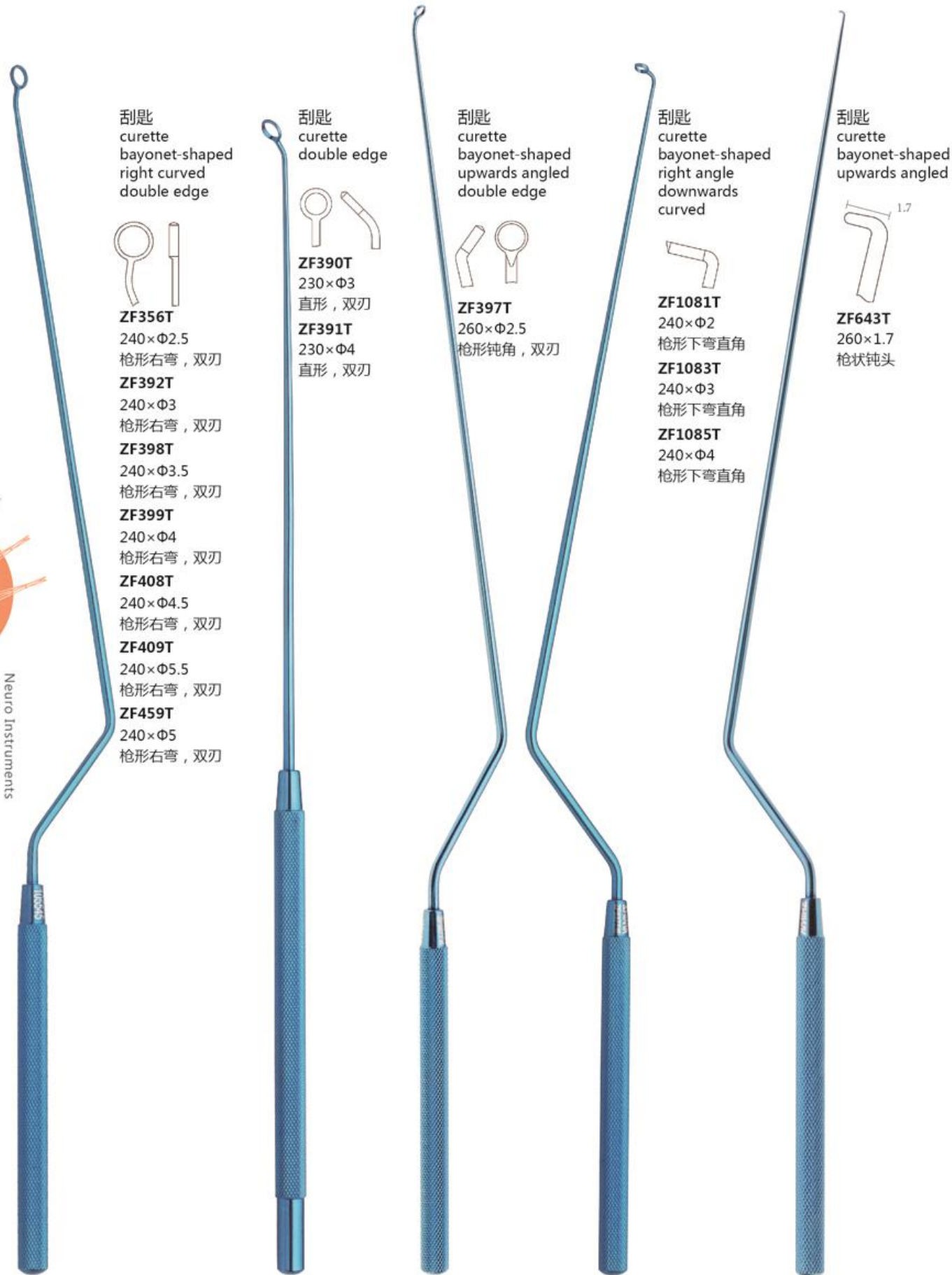

Neuro Instruments  
神经外科

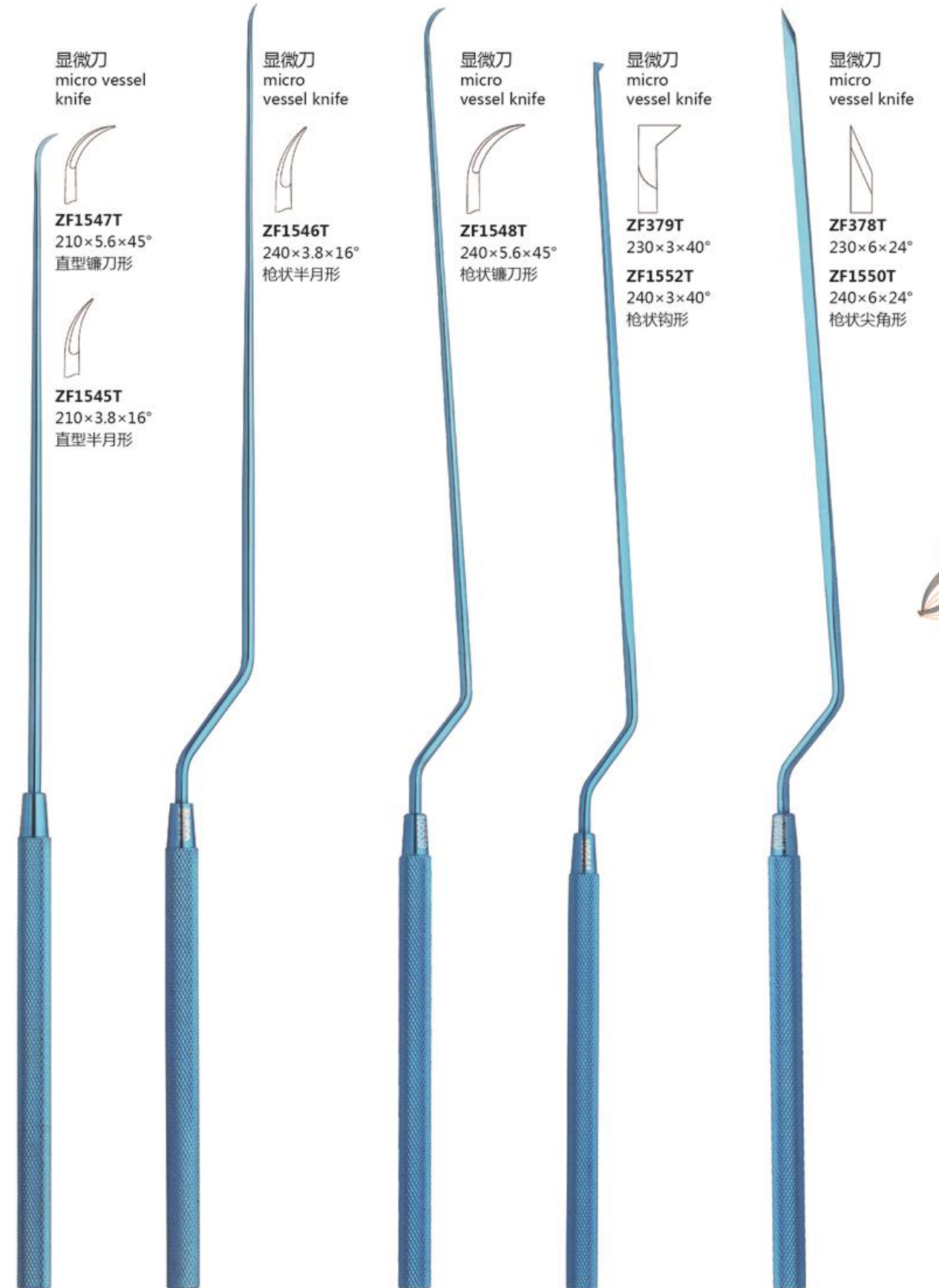

Neuro Instruments  
神经外科

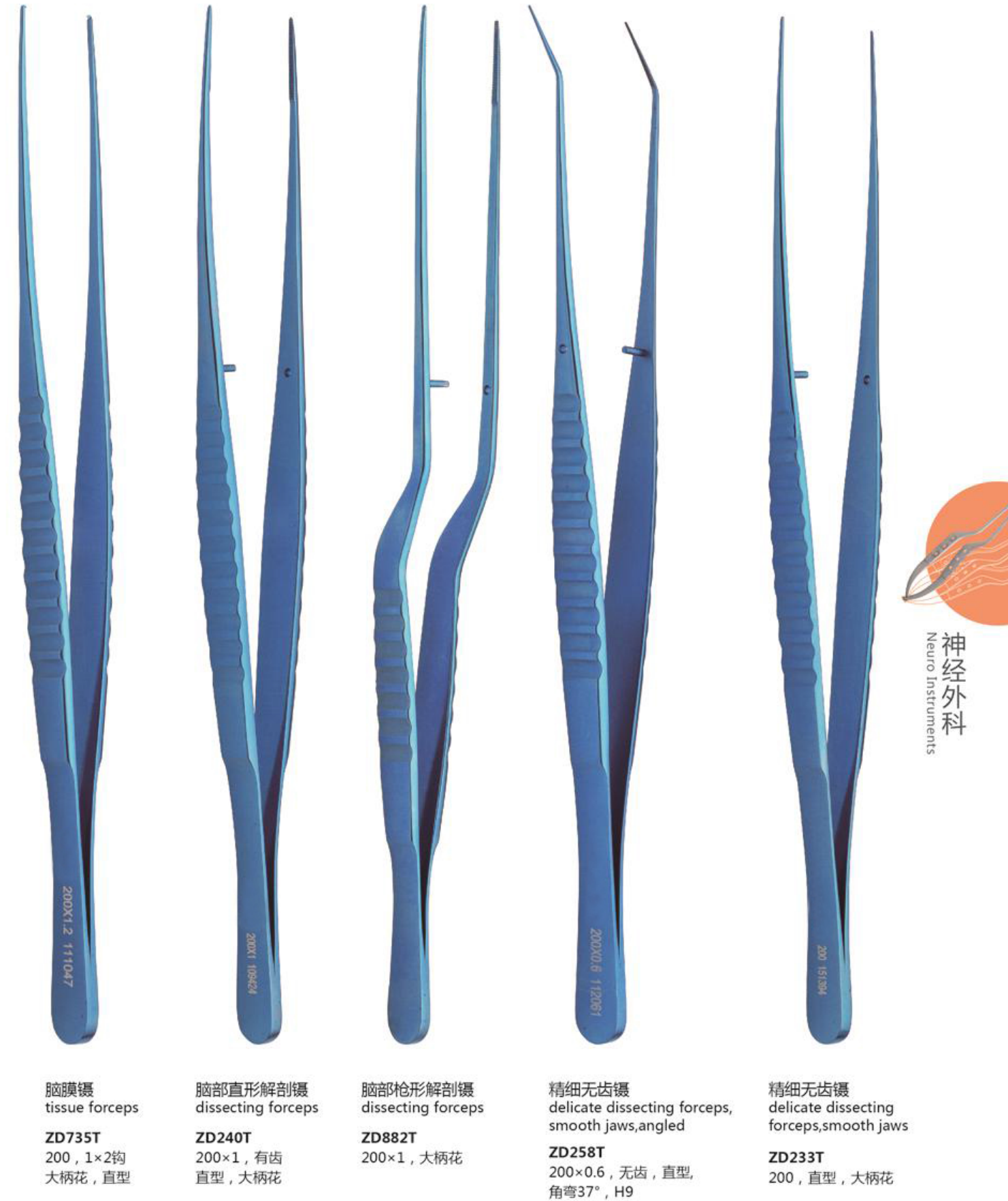
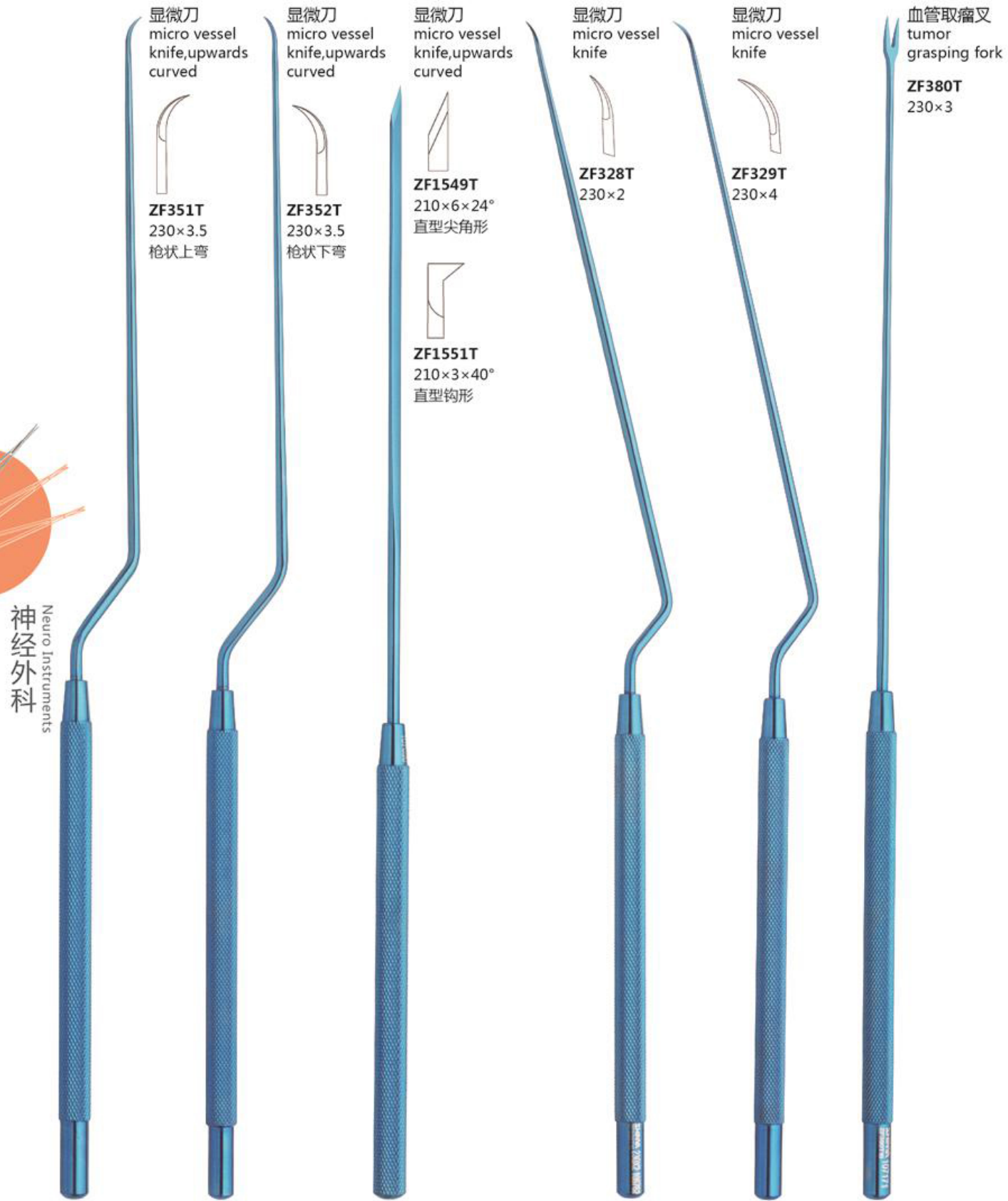

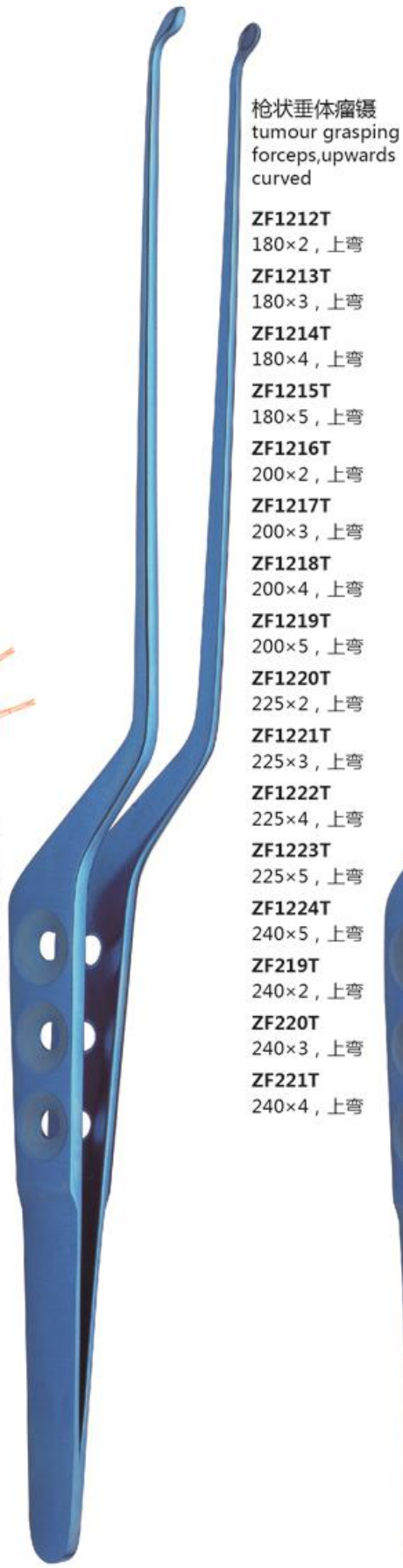

枪状垂体瘤镊  
tumour grasping  
forceps, upwards  
curved

- ZF1212T**  
180×2, 上弯
- ZF1213T**  
180×3, 上弯
- ZF1214T**  
180×4, 上弯
- ZF1215T**  
180×5, 上弯
- ZF1216T**  
200×2, 上弯
- ZF1217T**  
200×3, 上弯
- ZF1218T**  
200×4, 上弯
- ZF1219T**  
200×5, 上弯
- ZF1220T**  
225×2, 上弯
- ZF1221T**  
225×3, 上弯
- ZF1222T**  
225×4, 上弯
- ZF1223T**  
225×5, 上弯
- ZF1224T**  
240×5, 上弯
- ZF219T**  
240×2, 上弯
- ZF220T**  
240×3, 上弯
- ZF221T**  
240×4, 上弯

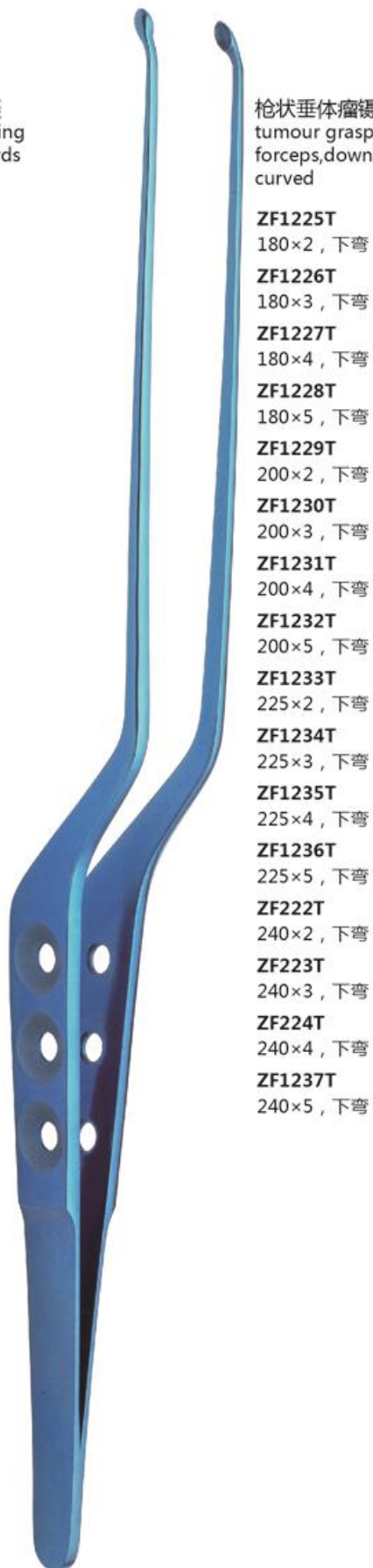

枪状垂体瘤镊  
tumour grasping  
forceps, downwards  
curved

- ZF1225T**  
180×2, 下弯
- ZF1226T**  
180×3, 下弯
- ZF1227T**  
180×4, 下弯
- ZF1228T**  
180×5, 下弯
- ZF1229T**  
200×2, 下弯
- ZF1230T**  
200×3, 下弯
- ZF1231T**  
200×4, 下弯
- ZF1232T**  
200×5, 下弯
- ZF1233T**  
225×2, 下弯
- ZF1234T**  
225×3, 下弯
- ZF1235T**  
225×4, 下弯
- ZF1236T**  
225×5, 下弯
- ZF222T**  
240×2, 下弯
- ZF223T**  
240×3, 下弯
- ZF224T**  
240×4, 下弯
- ZF1237T**  
240×5, 下弯

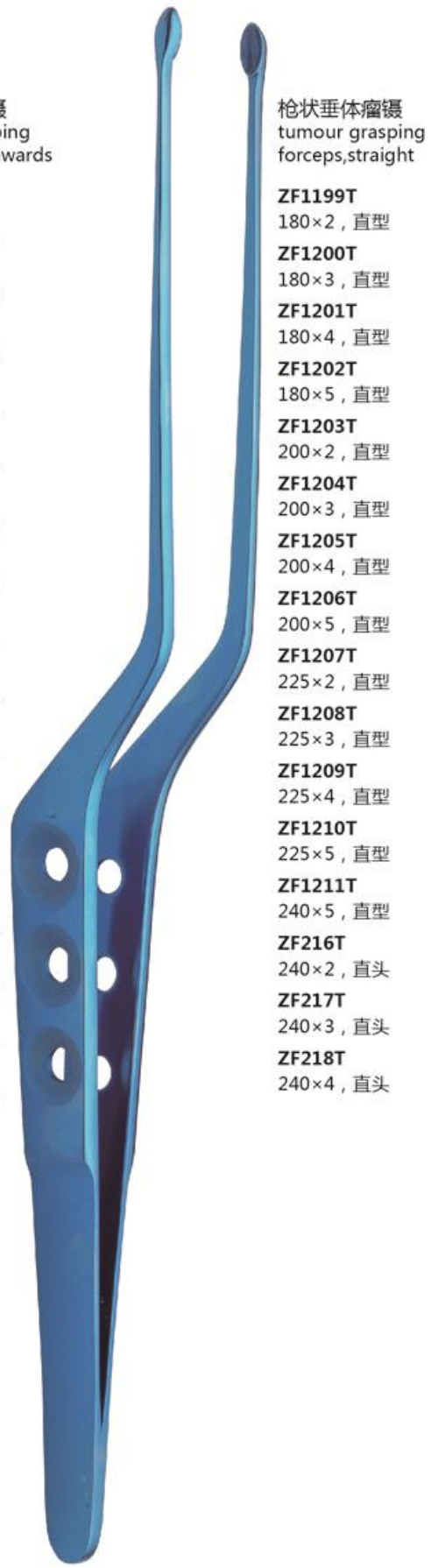

枪状垂体瘤镊  
tumour grasping  
forceps, straight

- ZF1199T**  
180×2, 直型
- ZF1200T**  
180×3, 直型
- ZF1201T**  
180×4, 直型
- ZF1202T**  
180×5, 直型
- ZF1203T**  
200×2, 直型
- ZF1204T**  
200×3, 直型
- ZF1205T**  
200×4, 直型
- ZF1206T**  
200×5, 直型
- ZF1207T**  
225×2, 直型
- ZF1208T**  
225×3, 直型
- ZF1209T**  
225×4, 直型
- ZF1210T**  
225×5, 直型
- ZF1211T**  
240×5, 直型
- ZF216T**  
240×2, 直头
- ZF217T**  
240×3, 直头
- ZF218T**  
240×4, 直头

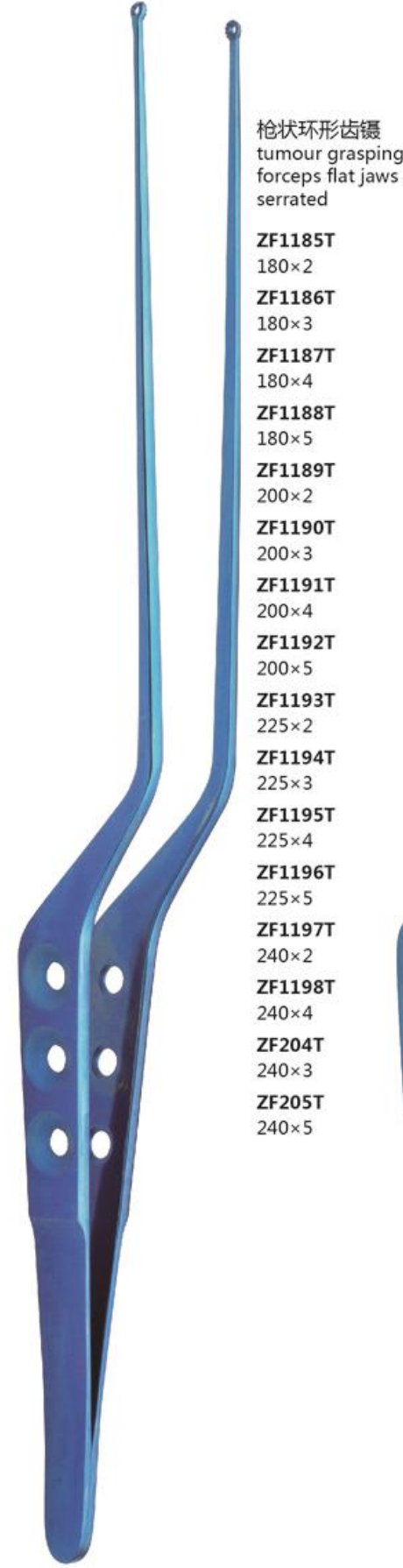

枪状环形齿镊  
tumour grasping  
forceps flat jaws  
serrated

- ZF1185T**  
180×2
- ZF1186T**  
180×3
- ZF1187T**  
180×4
- ZF1188T**  
180×5
- ZF1189T**  
200×2
- ZF1190T**  
200×3
- ZF1191T**  
200×4
- ZF1192T**  
200×5
- ZF1193T**  
225×2
- ZF1194T**  
225×3
- ZF1195T**  
225×4
- ZF1196T**  
225×5
- ZF1197T**  
240×2
- ZF1198T**  
240×4
- ZF204T**  
240×3
- ZF205T**  
240×5



枪状有齿取瘤镊  
tumour grasping  
forceps curette jaw  
serrated

- ZF206T**  
240×3
- ZF207T**  
240×5



枪状显微镊  
tumour grasping  
forceps bayonet-shaped  
smooth jaw

- ZF1238T**  
180×0.6, 无齿
- ZF1239T**  
200×0.6, 无齿
- ZF1240T**  
225×0.6, 无齿
- ZF840T**  
240×0.6, 无齿



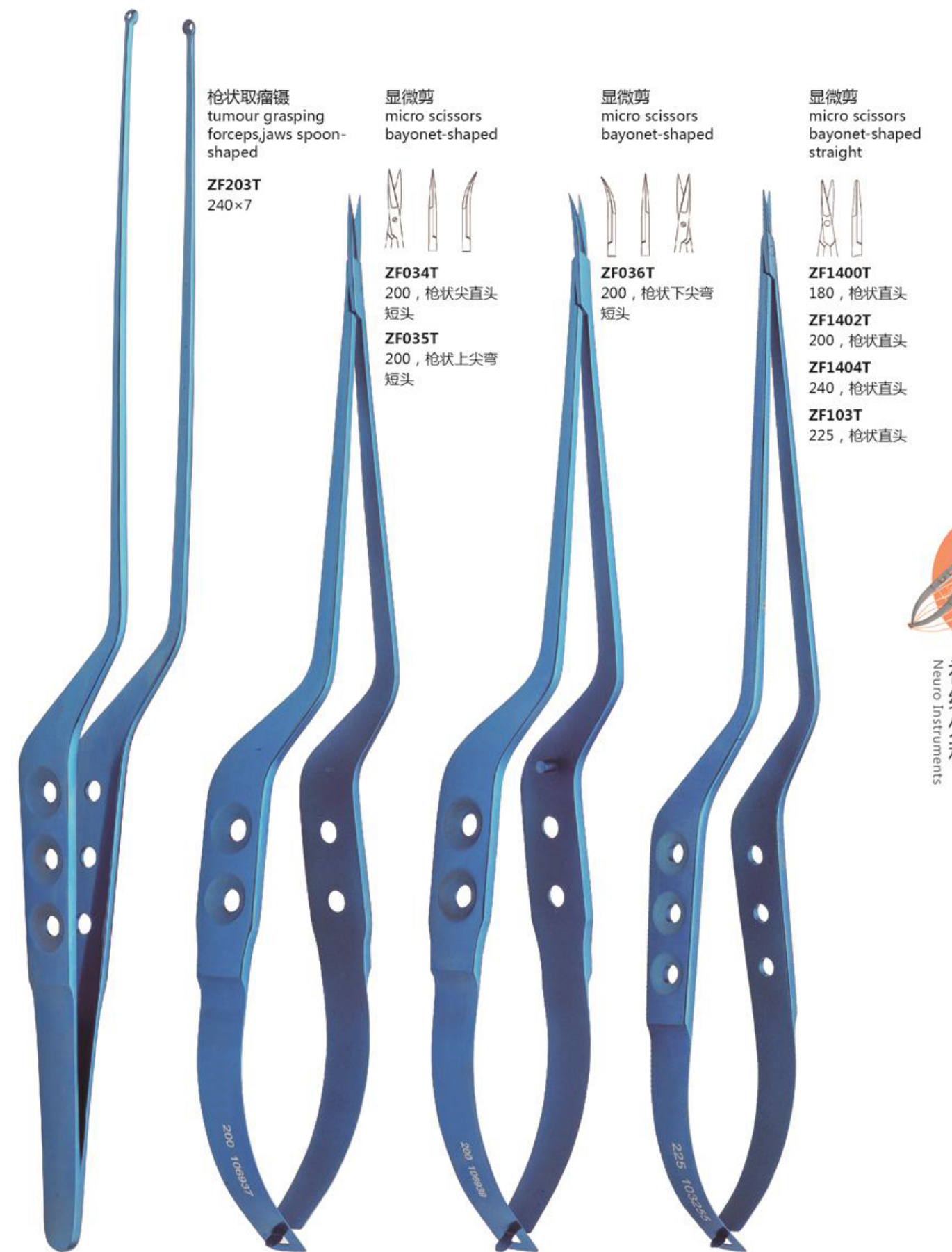
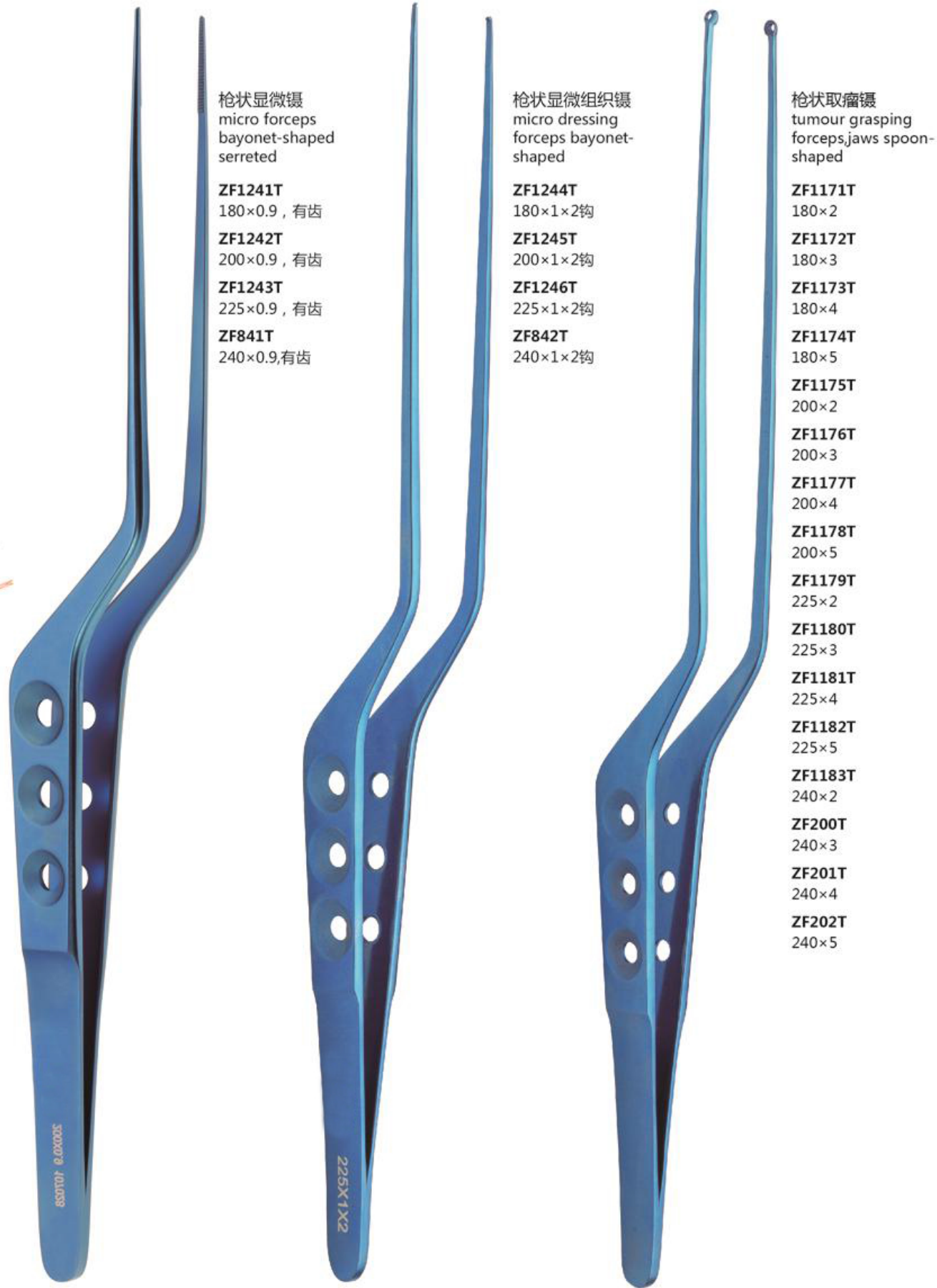

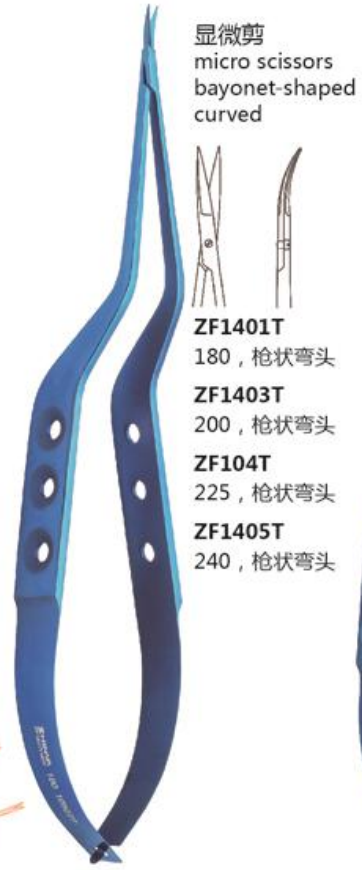

显微剪  
micro scissors  
bayonet-shaped  
curved



**ZF1401T**  
180, 枪状弯头  
**ZF1403T**  
200, 枪状弯头  
**ZF104T**  
225, 枪状弯头  
**ZF1405T**  
240, 枪状弯头

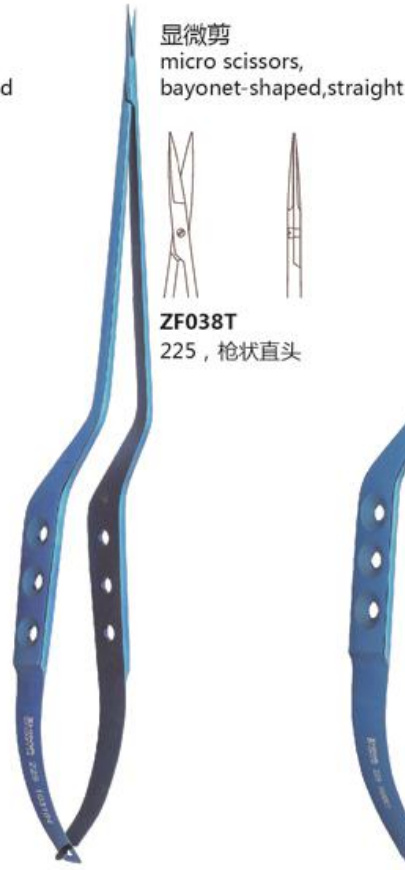

显微剪  
micro scissors,  
bayonet-shaped, straight

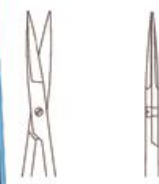

**ZF038T**  
225, 枪状直头

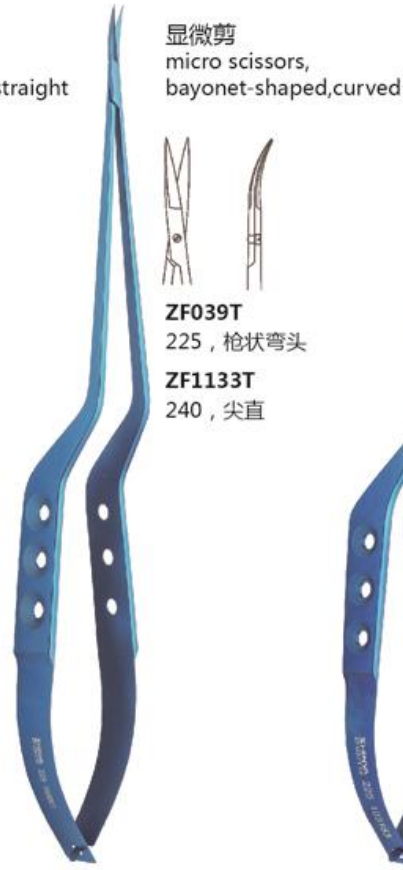

显微剪  
micro scissors,  
bayonet-shaped, curved

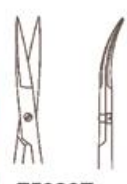

**ZF039T**  
225, 枪状弯头  
**ZF1133T**  
240, 尖直



显微剪  
micro scissors,  
bayonet-shaped

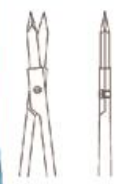

**ZF037T**  
225, 枪状尖头直



显微剪  
micro scissors  
bayonet-shaped



**ZF2362T**  
205, 枪状弯头



显微持针钳  
micro needle  
holder, curved

**ZF049T**  
200, 方柄弯头



显微持针钳  
micro needle  
holder, straight

**ZF048T**  
200, 方柄直头

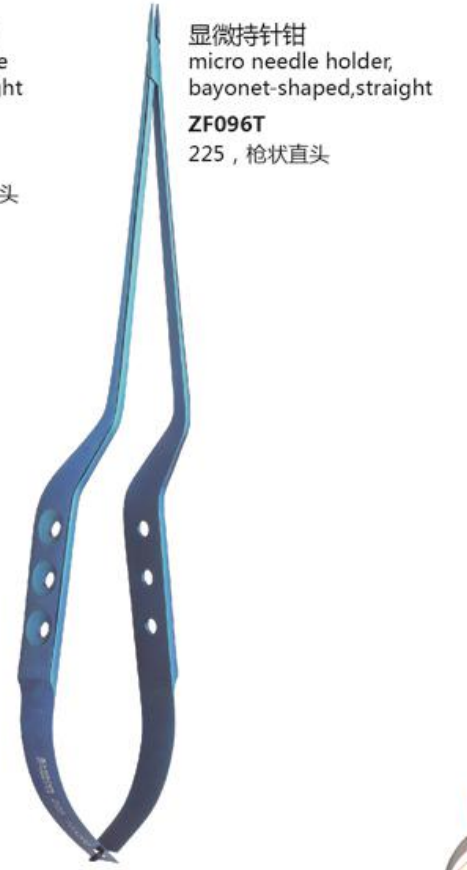

显微持针钳  
micro needle holder,  
bayonet-shaped, straight

**ZF096T**  
225, 枪状直头



显微剪  
micro scissors  
bayonet-shaped



**ZF040T**  
225, 枪状尖头弯



显微剪  
micro scissors,  
bayonet-shaped

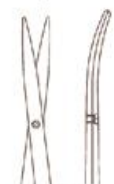

**ZF043T**  
225, 枪状长圆弯



显微剪  
micro scissors,  
bayonet-shaped

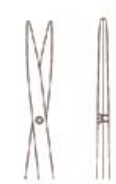

**ZF044T**  
225, 枪状长圆直



显微剪  
micro scissors  
bayonet-shaped



**ZF2361T**  
205, 枪状直头



显微持针钳  
micro needle holder,  
bayonet-shaped, curved

**ZF097T**  
225, 枪状弯头



显微持针钳  
micro needle holder,  
with catch, straight

**ZF2440T**  
210, 圆柄直头, 自锁式



显微持针钳  
micro needle holder,  
with catch, curved

**ZF2441T**  
210, 圆柄弯头, 自锁式

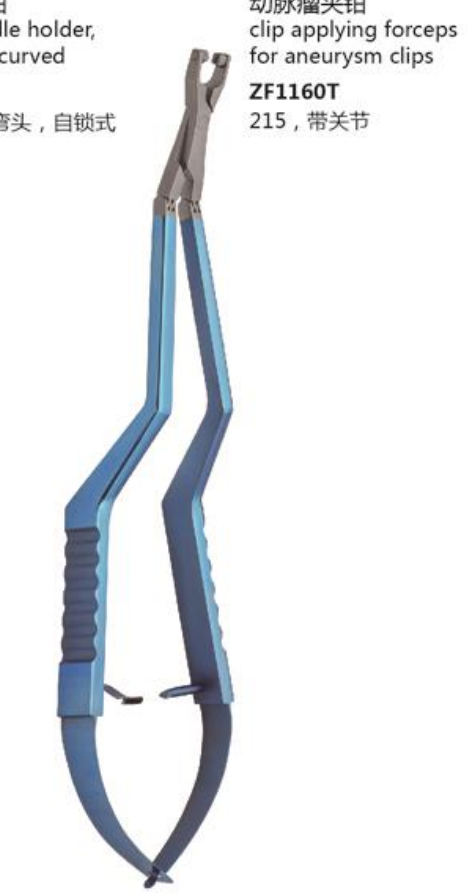

动脉瘤夹钳  
clip applying forceps  
for aneurysm clips

**ZF1160T**  
215, 带关节

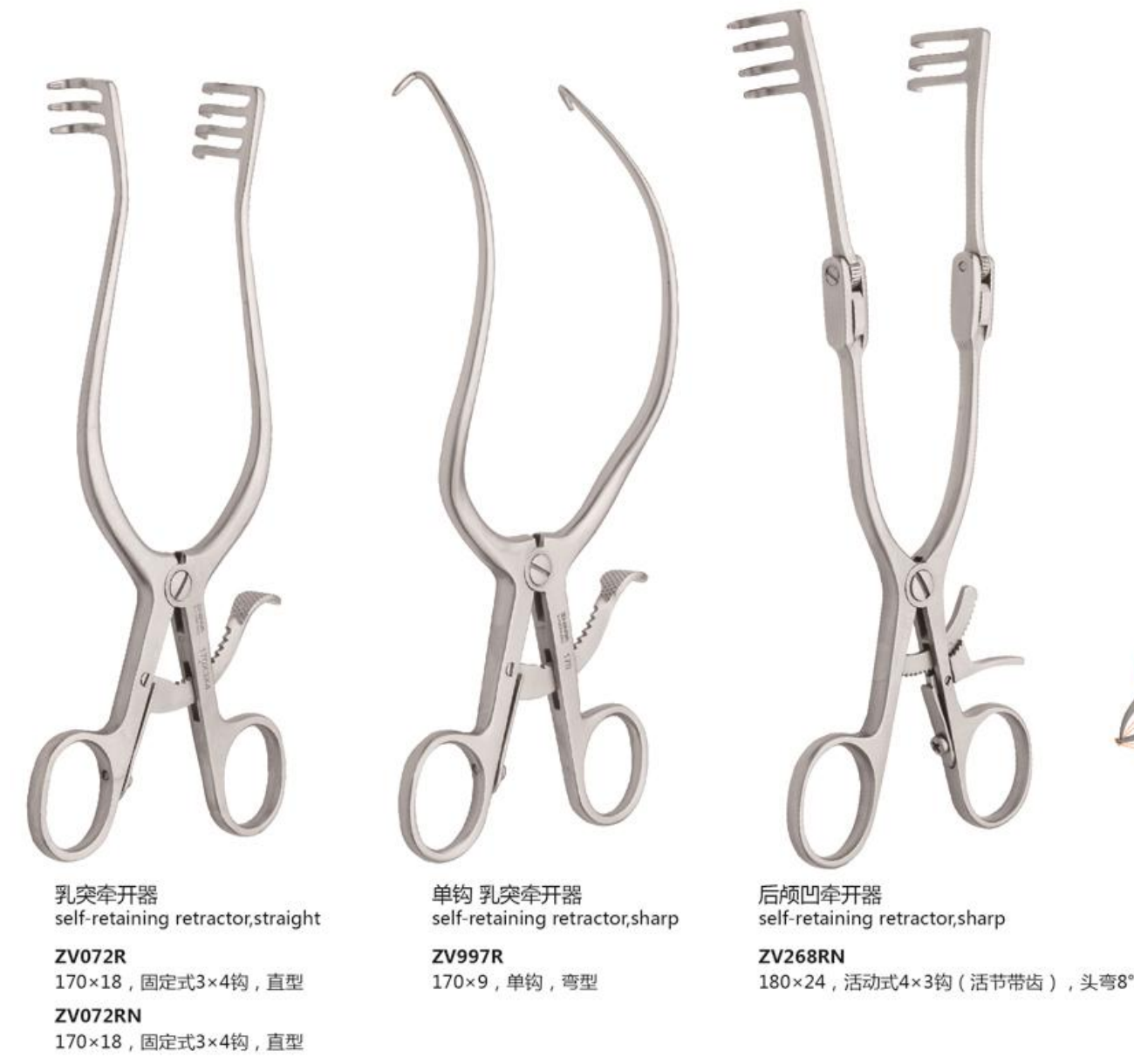

Neuro Instruments  
神经外科

Neuro Instruments  
神经外科



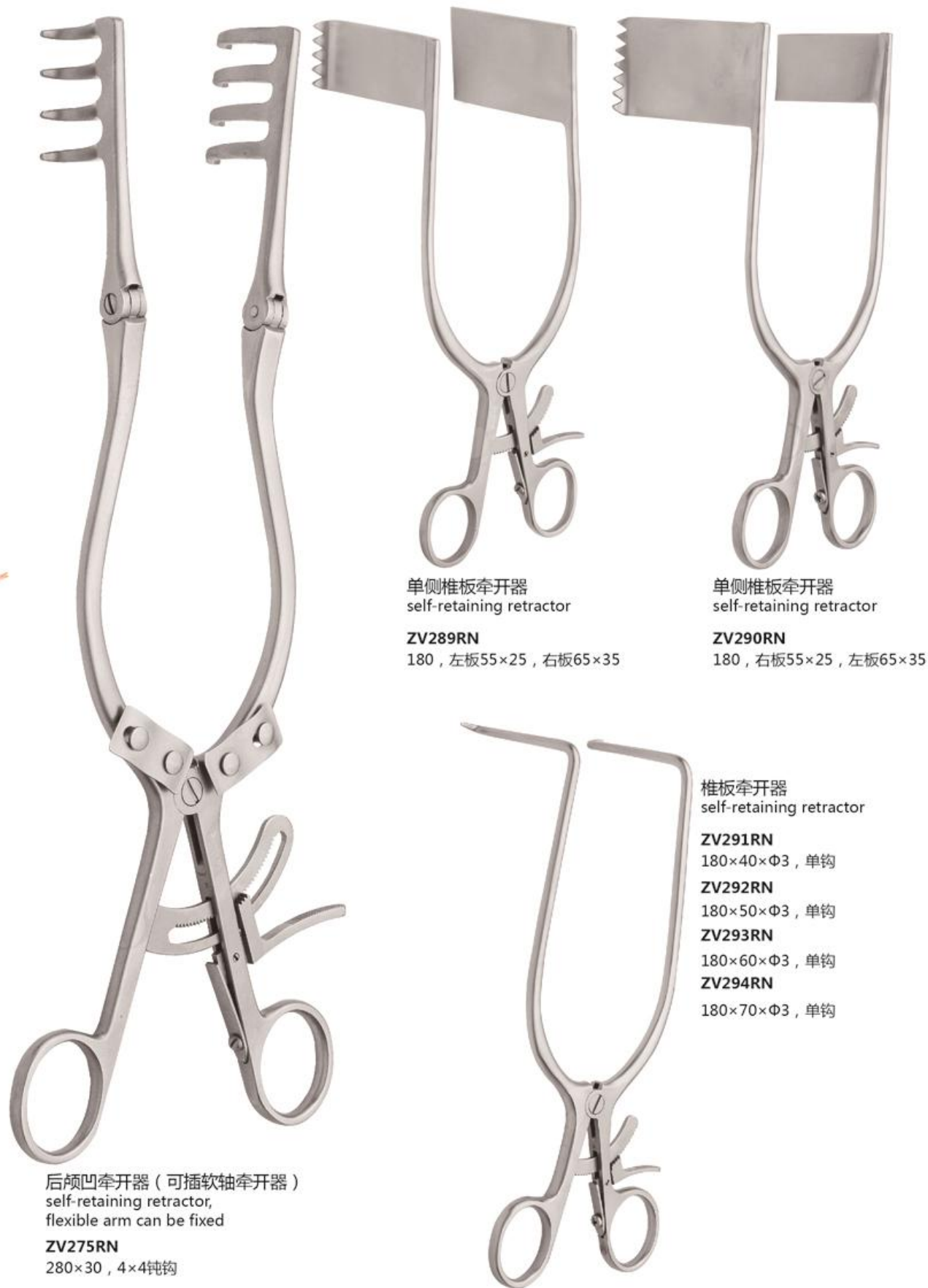

后颅凹牵开器 (可插软轴牵开器)  
self-retaining retractor,  
flexible arm can be fixed  
**ZV275RN**  
280×30, 4×4钝钩

单侧椎板牵开器  
self-retaining retractor  
**ZV289RN**  
180, 左板55×25, 右板65×35

单侧椎板牵开器  
self-retaining retractor  
**ZV290RN**  
180, 右板55×25, 左板65×35

椎板牵开器  
self-retaining retractor  
**ZV291RN**  
180×40×Φ3, 单钩  
**ZV292RN**  
180×50×Φ3, 单钩  
**ZV293RN**  
180×60×Φ3, 单钩  
**ZV294RN**  
180×70×Φ3, 单钩

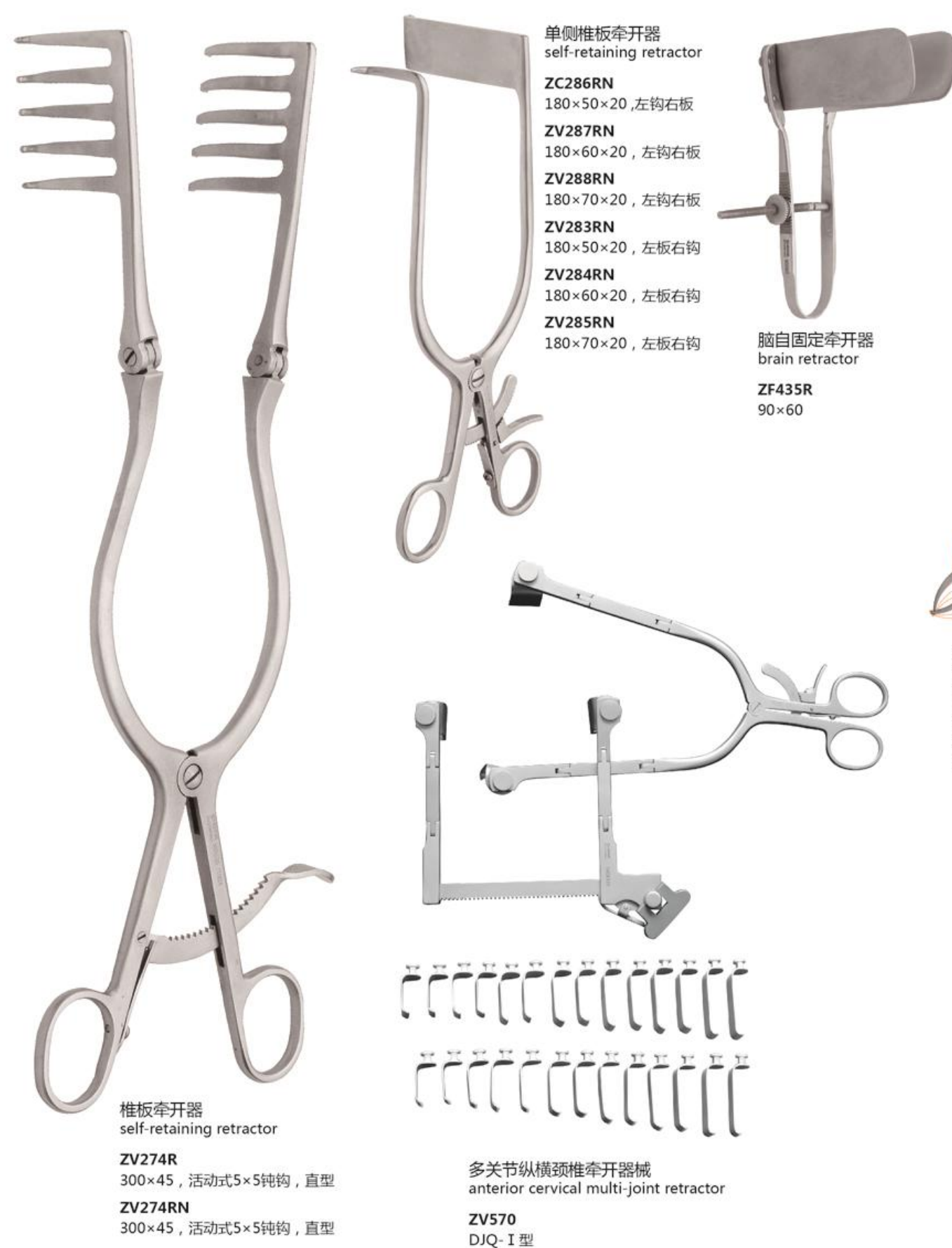

单侧椎板牵开器  
self-retaining retractor  
**ZC286RN**  
180×50×20, 左钩右板  
**ZV287RN**  
180×60×20, 左钩右板  
**ZV288RN**  
180×70×20, 左钩右板  
**ZV283RN**  
180×50×20, 左板右钩  
**ZV284RN**  
180×60×20, 左板右钩  
**ZV285RN**  
180×70×20, 左板右钩

脑自固定牵开器  
brain retractor  
**ZF435R**  
90×60

椎板牵开器  
self-retaining retractor  
**ZV274R**  
300×45, 活动式5×5钝钩, 直型  
**ZV274RN**  
300×45, 活动式5×5钝钩, 直型

多关节纵横颈椎牵开器械  
anterior cervical multi-joint retractor  
**ZV570**  
DJQ- I 型

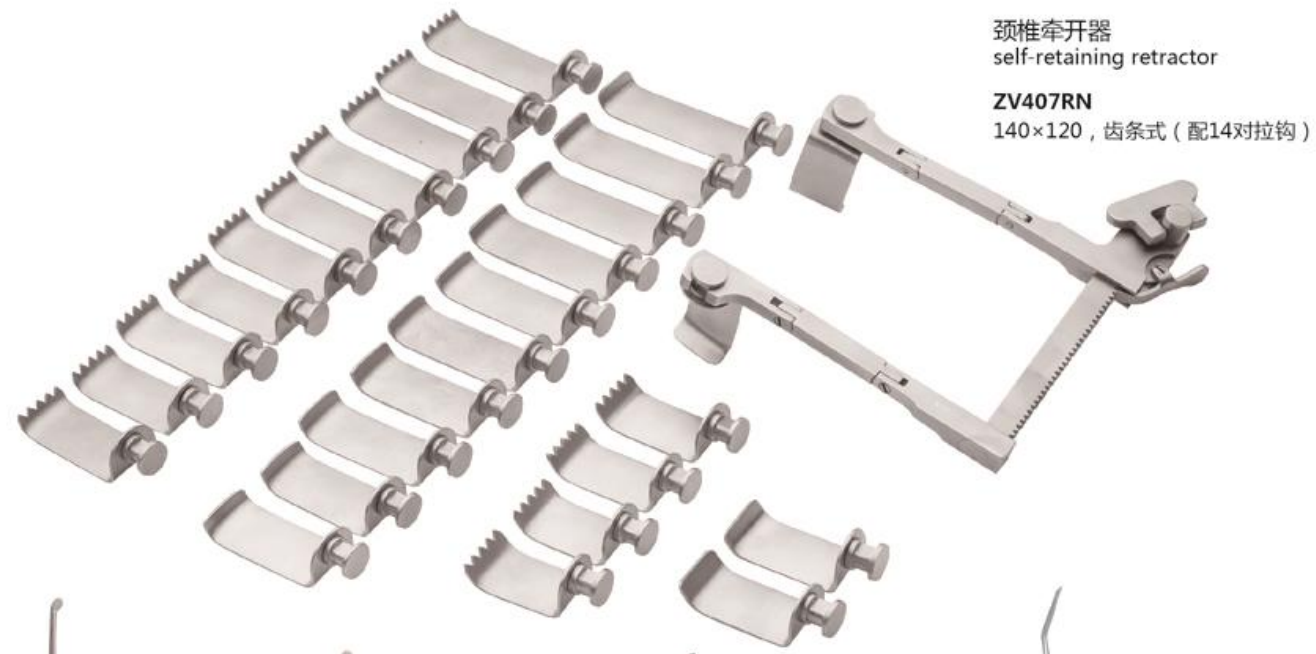

颈椎牵开器  
self-retaining retractor  
**ZV407RN**  
140×120, 齿条式 (配14对拉钩)

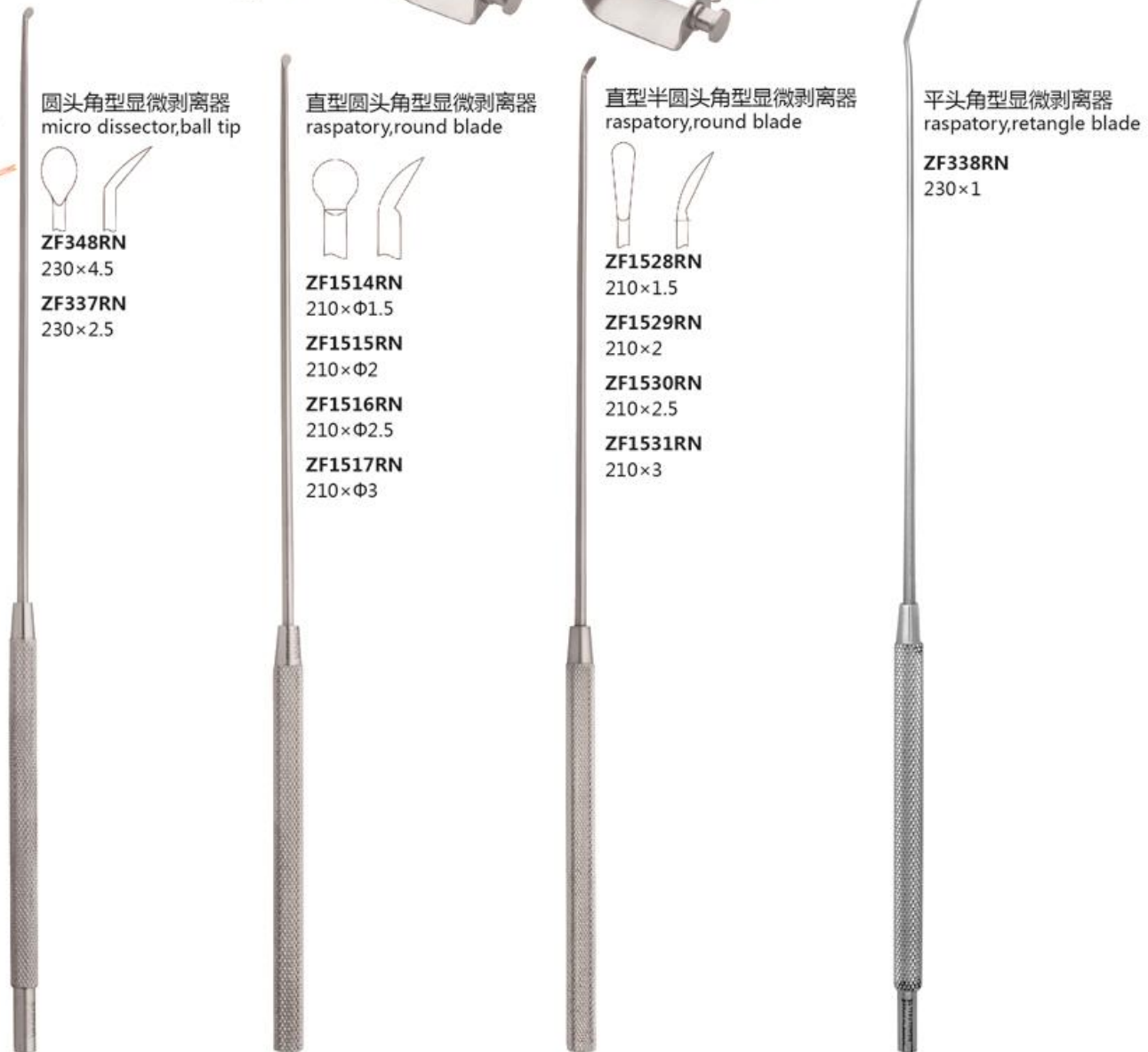

圆头角型显微剥离器  
micro dissector, ball tip  
**ZF348RN**  
230×4.5  
**ZF337RN**  
230×2.5

直型圆头角型显微剥离器  
raspatory, round blade  
**ZF1514RN**  
210×Φ1.5  
**ZF1515RN**  
210×Φ2  
**ZF1516RN**  
210×Φ2.5  
**ZF1517RN**  
210×Φ3

直型半圆头角型显微剥离器  
raspatory, round blade  
**ZF1528RN**  
210×1.5  
**ZF1529RN**  
210×2  
**ZF1530RN**  
210×2.5  
**ZF1531RN**  
210×3

平头角型显微剥离器  
raspatory, rectangle blade  
**ZF338RN**  
230×1

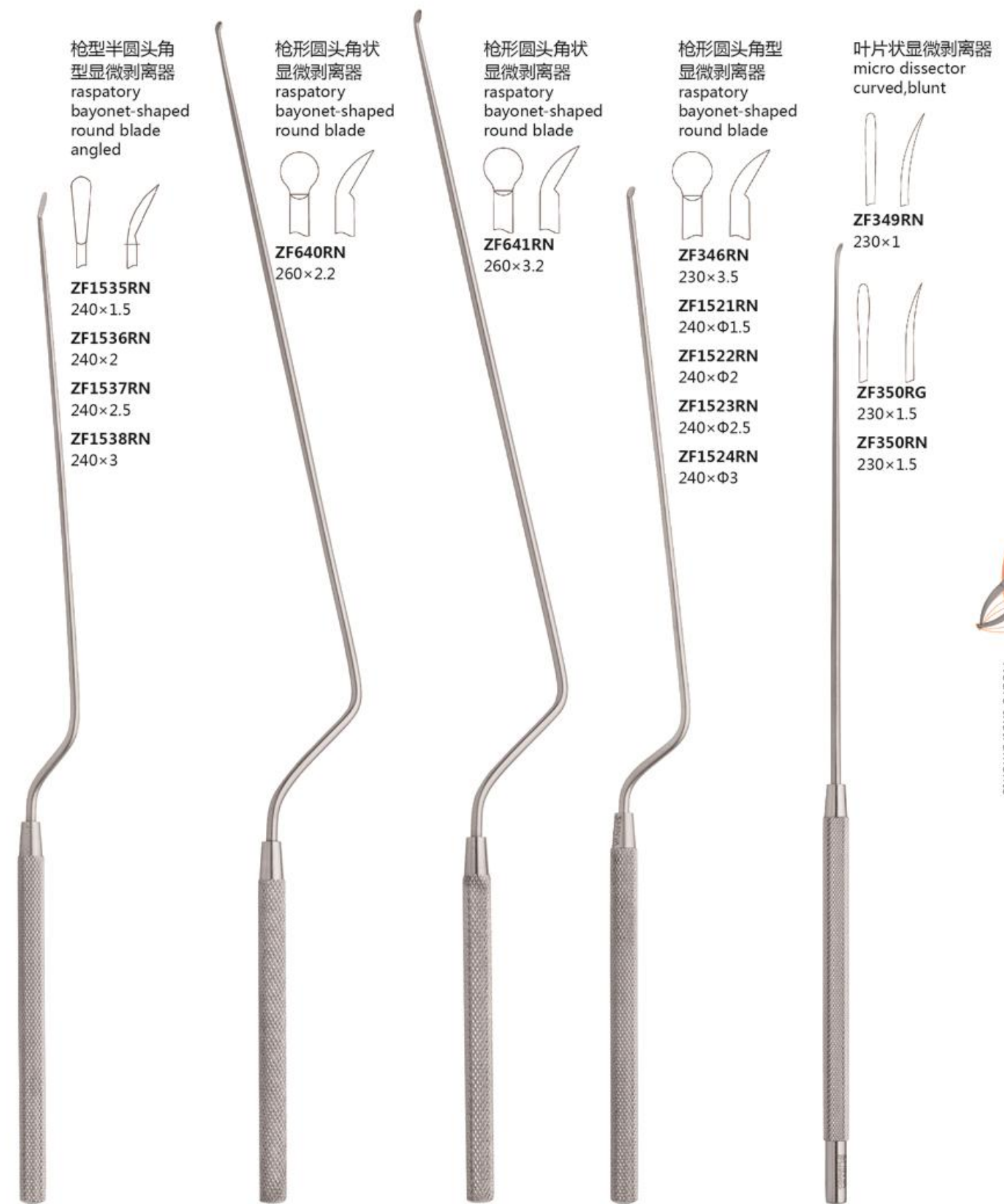

枪型半圆头角型显微剥离器  
raspatory bayonet-shaped round blade angled  
**ZF1535RN**  
240×1.5  
**ZF1536RN**  
240×2  
**ZF1537RN**  
240×2.5  
**ZF1538RN**  
240×3

枪形圆头角状显微剥离器  
raspatory bayonet-shaped round blade  
**ZF640RN**  
260×2.2

枪形圆头角状显微剥离器  
raspatory bayonet-shaped round blade  
**ZF641RN**  
260×3.2

枪形圆头角型显微剥离器  
raspatory bayonet-shaped round blade  
**ZF346RN**  
230×3.5  
**ZF1521RN**  
240×Φ1.5  
**ZF1522RN**  
240×Φ2  
**ZF1523RN**  
240×Φ2.5  
**ZF1524RN**  
240×Φ3

叶片状显微剥离器  
micro dissector curved, blunt  
**ZF349RN**  
230×1  
**ZF350RG**  
230×1.5  
**ZF350RN**  
230×1.5



Neuro Instruments  
神经外科



Neuro Instruments  
神经外科



Neuro Instruments  
神经外科

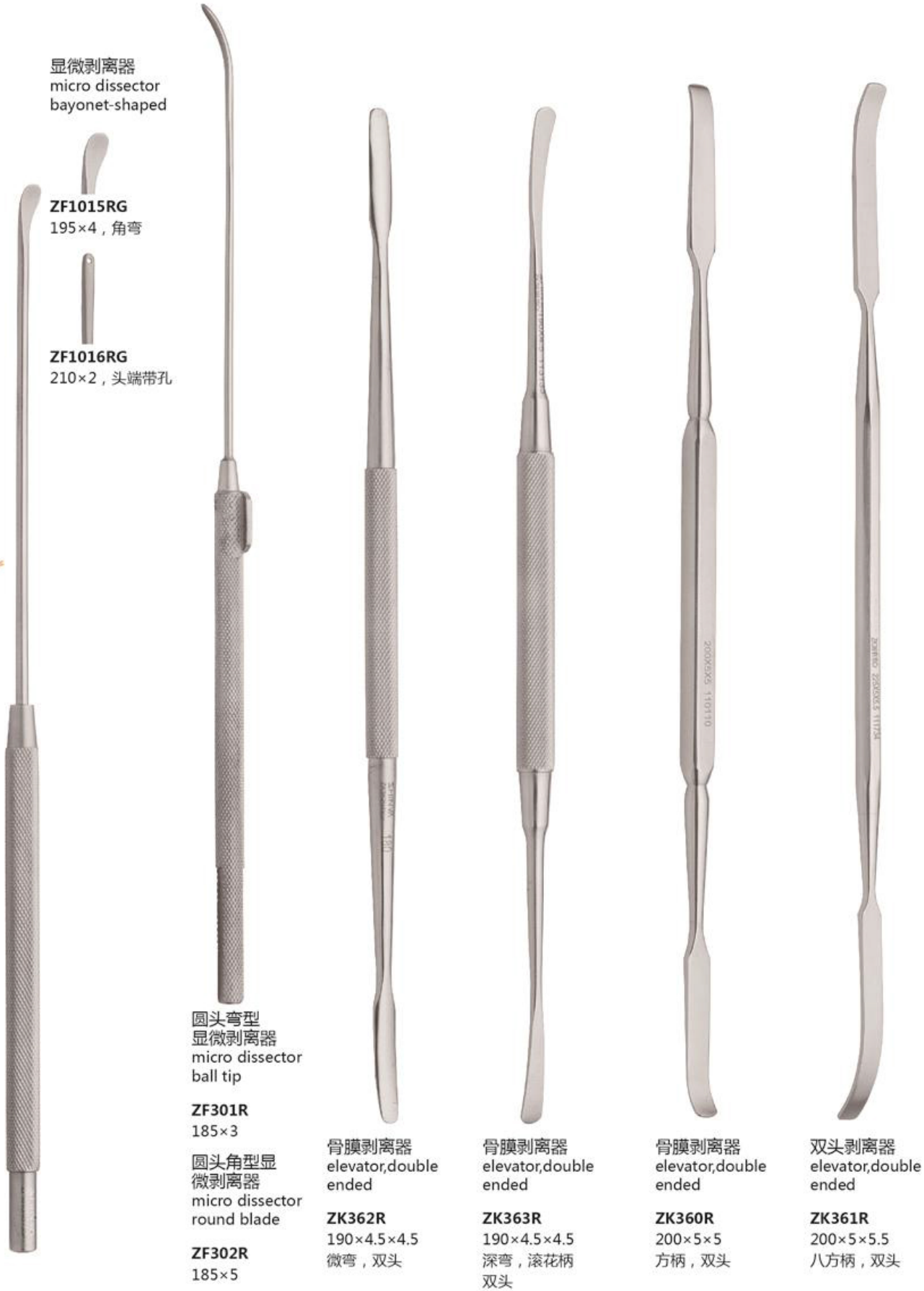

Neuro Instruments  
神经外科



Neuro Instruments  
神经外科



双头剥离器  
elevator, double ended  
**ZF225RN**  
210×2, 脑膜  
**ZF226RN**  
210×3, 脑膜  
**ZF227RN**  
210×4, 脑膜  
**ZF228RN**  
220×4, 脑膜  
**ZF229RN**  
240×5, 脑膜



枪状左弯垂  
体瘤剥离器  
tumour grasping  
forceps, bayonet-  
shaped, left curved  
sharp  
**ZF366RN**  
230×7锐  
**ZF368RN**  
230×7钝



枪状右弯垂  
体瘤剥离器  
tumour grasping  
forceps, bayonet-  
shaped, right curved  
sharp  
**ZF367RN**  
230×7锐  
**ZF369RN**  
230×7钝



鼻中隔剥离器  
nasel septum  
dissector, straight  
**ZO547RN**  
220×3, 直型  
**ZO548RN**  
220×4, 直型



鼻中隔剥离器  
nasel septum  
dissector, bayonet-  
shape, upwards  
curved  
**ZO549RN**  
240×3, 枪型  
上弯  
**ZO550RN**  
240×4, 枪型  
上弯  
**ZO551RN**  
240×6, 枪型  
上弯



鼻中隔剥离器  
nasel septum  
dissector, bayonet-  
shape, downwards  
curved  
**ZO552RN**  
240×3, 枪型, 下弯  
**ZO553RN**  
240×4, 枪型, 下弯  
**ZO554RN**  
240×6, 枪型, 下弯



枪形球头剥离器  
raspatory, ball  
pointed  
**ZF381RG**  
230×Φ1  
**ZF381RN**  
230×Φ1



直型球头剥离器  
raspatory, ball  
pointed  
**ZF1408RN**  
210×Φ0.6  
**ZF1410RN**  
210×Φ1  
**ZF429RG**  
230×Φ1  
**ZF429RN**  
230×Φ1



枪型球头剥离器  
raspatory, bayonet-  
shaped, ball  
pointed  
**ZF1409RN**  
240×Φ0.6  
**ZF1411RN**  
240×Φ1



弯头颅骨骨膜剥离器  
periosteum elevator  
curved  
**ZK347RN**  
180×2 (滚花柄)  
**ZK348RN**  
200×3 (滚花柄)



Neuro Instruments  
神经外科





Neuro Instruments  
神经外科

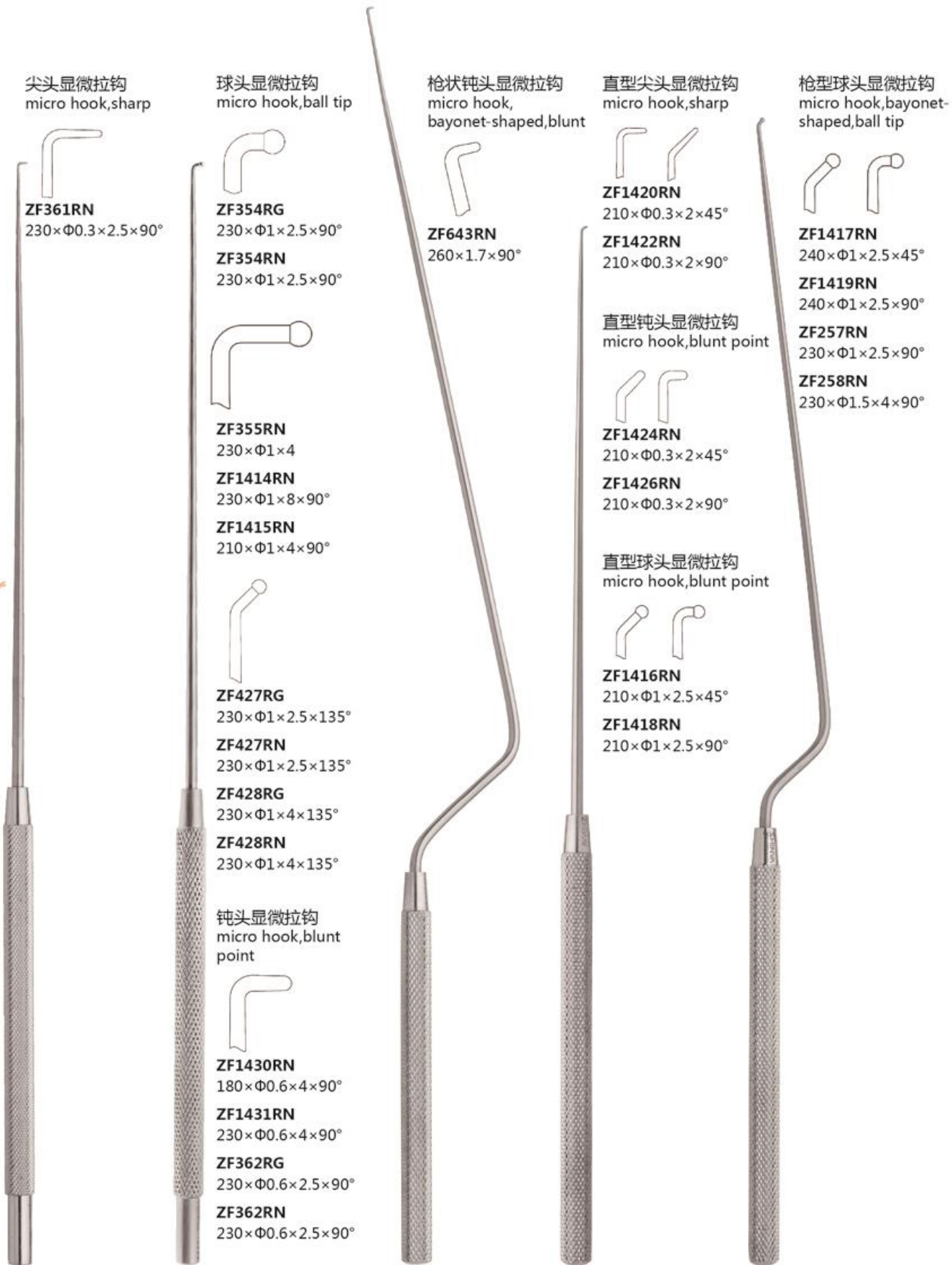

Neuro Instruments  
神经外科



神经外科  
Neuro Instruments



头皮拉钩  
retractor,blunt

**ZT249R**  
220

直型神经  
根拉钩  
love nerve  
root retractor

**ZF701R**  
240

颅骨骨撬  
skull elevator,blunt

**ZK356R**  
190 (铝柄)  
**ZK356RN**  
190 (铝柄)

弯头颅骨骨膜剥离器  
periosteum elevator  
curved

**ZK351R**  
160×11 (铝柄)  
**ZK351RN**  
160×11 (铝柄)  
**ZK357R**  
160×8 (铝柄)

直头颅骨骨  
膜剥离器  
periosteum  
elevator,straight

**ZK350R**  
200×8 (铝柄)  
**ZK350RN**  
200×8 (铝柄)



神经外科  
Neuro Instruments



微弯头颅骨骨  
膜剥离器  
periosteum elevator  
slightly curved

**ZK352R**  
220×10 (铝柄)  
**ZK352RN**  
220×10 (铝柄)

微弯头颅骨  
骨膜剥离器  
periosteum  
elevator,slightly  
curved

**ZK353R**  
220×15 (铝柄)  
**ZK353RN**  
220×15 (铝柄)

椎板剥离器  
laminectomy  
elevator

**ZK354R**  
220×15 (铝柄)  
**ZK354RN**  
220×15 (铝柄)

椎板剥离器  
laminectomy  
elevator

**ZK355R**  
220×20 (铝柄)  
**ZK355RN**  
220×20 (铝柄)

微弯头颅骨骨膜剥离器  
periosteum elevator  
slightly curved

**ZK349RN**  
220×5 (铝柄)

注：R产品铝柄为墨绿色  
RN产品铝柄为黑色



神经外科  
Neuro Instruments



角型神经拉钩 love nerve root retractor <b>ZF703R</b> 120×120×90°×10	神经根拉钩 love nerve root retractor <b>ZQ935RN</b> 150×95×4×90°	神经根拉钩 love nerve root retractor <b>ZQ933RN</b> 210×4×135°	神经根拉钩 love nerve root retractor <b>ZQ931RN</b> 240×4×9, 直型	枪状神经根压钩 love nerve root retractor bayonet-shaped <b>ZF702R</b> 210×5	消毒支架 frame <b>ZF021R</b> 220
--	--	--	---	---	---------------------------------------



神经外科  
Neuro Instruments

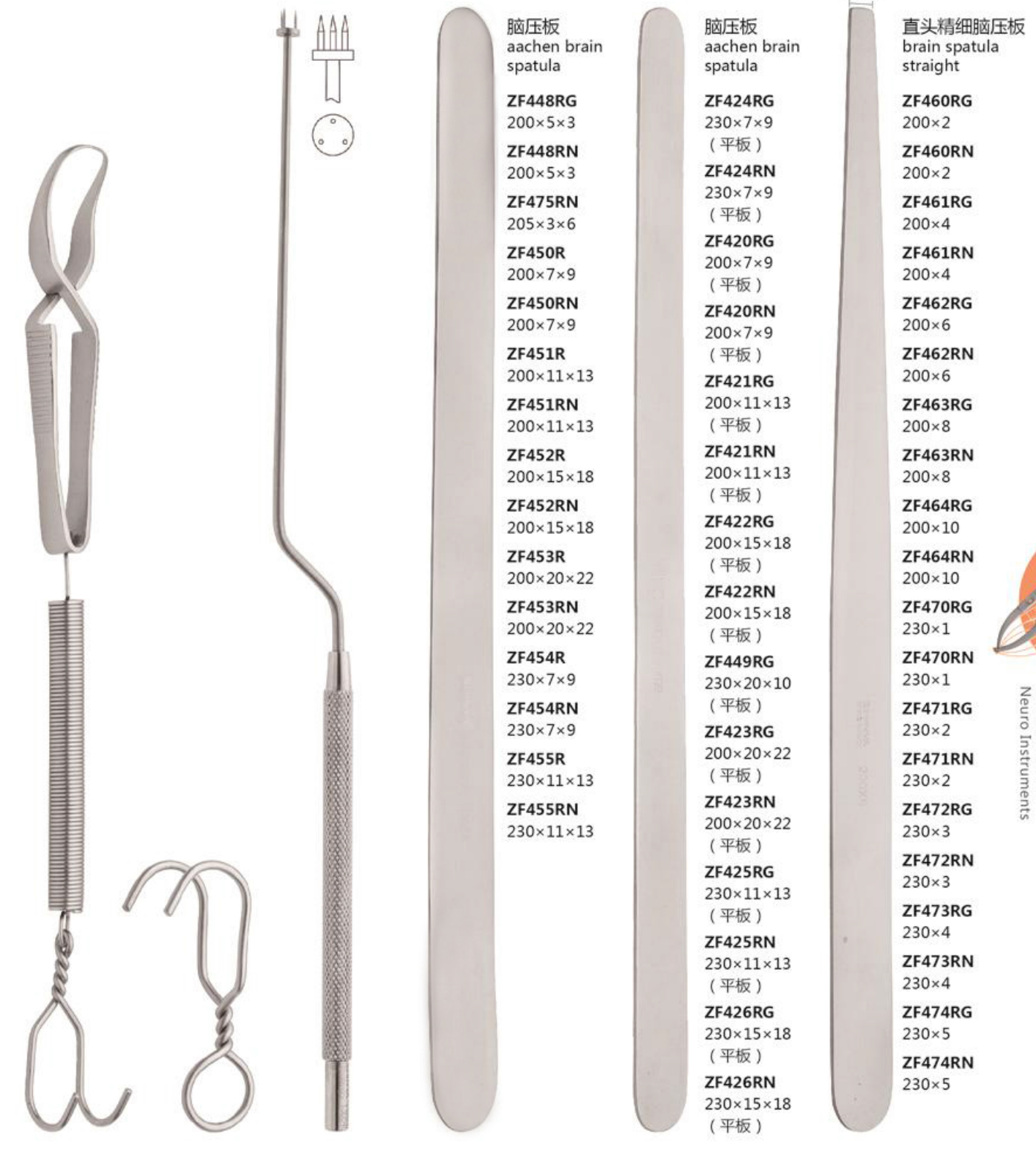

弹簧头皮拉钩 yasargil galea hook, blunt <b>ZF020R</b> 200, 钝钩	头皮拉钩 retractor, blunt <b>ZF008R</b> 45×13.5, 钝	骨片按置器 cartilage implant fork <b>ZF330RN</b> 230×4	脑压板 aachen brain spatula <b>ZF448RG</b> 200×5×3 <b>ZF448RN</b> 200×5×3 <b>ZF475RN</b> 205×3×6 <b>ZF450R</b> 200×7×9 <b>ZF450RN</b> 200×7×9 <b>ZF451R</b> 200×11×13 <b>ZF451RN</b> 200×11×13 <b>ZF452R</b> 200×15×18 <b>ZF452RN</b> 200×15×18 <b>ZF453R</b> 200×20×22 <b>ZF453RN</b> 200×20×22 <b>ZF454R</b> 230×7×9 <b>ZF454RN</b> 230×7×9 <b>ZF455R</b> 230×11×13 <b>ZF455RN</b> 230×11×13	脑压板 aachen brain spatula <b>ZF424RG</b> 230×7×9 (平板) <b>ZF424RN</b> 230×7×9 (平板) <b>ZF420RG</b> 200×7×9 (平板) <b>ZF420RN</b> 200×7×9 (平板) <b>ZF421RG</b> 200×11×13 (平板) <b>ZF421RN</b> 200×11×13 (平板) <b>ZF422RG</b> 200×15×18 (平板) <b>ZF422RN</b> 200×15×18 (平板) <b>ZF449RG</b> 230×20×10 (平板) <b>ZF423RG</b> 200×20×22 (平板) <b>ZF423RN</b> 200×20×22 (平板) <b>ZF425RG</b> 230×11×13 (平板) <b>ZF425RN</b> 230×11×13 (平板) <b>ZF426RG</b> 230×15×18 (平板) <b>ZF426RN</b> 230×15×18 (平板)	直头精细脑压板 brain spatula straight <b>ZF460RG</b> 200×2 <b>ZF460RN</b> 200×2 <b>ZF461RG</b> 200×4 <b>ZF461RN</b> 200×4 <b>ZF462RG</b> 200×6 <b>ZF462RN</b> 200×6 <b>ZF463RG</b> 200×8 <b>ZF463RN</b> 200×8 <b>ZF464RG</b> 200×10 <b>ZF464RN</b> 200×10 <b>ZF470RG</b> 230×1 <b>ZF470RN</b> 230×1 <b>ZF471RG</b> 230×2 <b>ZF471RN</b> 230×2 <b>ZF472RG</b> 230×3 <b>ZF472RN</b> 230×3 <b>ZF473RG</b> 230×4 <b>ZF473RN</b> 230×4 <b>ZF474RG</b> 230×5 <b>ZF474RN</b> 230×5
--	---	--	--	--	---



Neuro Instruments  
神经外科



- |  |  |   |   |   |   |
|--|--|---|---|---|---|
| 弯头精细<br>脑压板<br>brain spatula<br>straight | 弯头精细<br>脑压板<br>brain spatula<br>straight | 弯头精细脑压板<br>brain spatula, straight              | 直头精细脑压板<br>brain spatula, straight<br>graduated | 弯头精细脑压板<br>brain spatula<br>curved, graduated | 弯头精细脑压板<br>brain spatula, curved<br>graduated |
| <b>ZF468RG</b><br>200×8 (三齿)             | <b>ZF469RG</b><br>200×10 (四齿)            | <b>ZF465RG</b> <b>ZF467RG</b><br>200×2    200×6 | <b>ZF1615RN</b><br>200×2, 带刻度                   | <b>ZF1620RN</b><br>200×2, 带刻度                 | <b>ZF1625RN</b><br>200×4 (两齿)<br>带刻度          |
| <b>ZF468RN</b><br>200×8 (三齿)             | <b>ZF469RN</b><br>200×10 (四齿)            | <b>ZF465RN</b> <b>ZF467RN</b><br>200×2    200×6 | <b>ZF1616RN</b><br>200×4, 带刻度                   | <b>ZF1621RN</b><br>200×4, 带刻度                 |   |
|  |  | <b>ZF466RG</b> <b>ZF478RG</b><br>200×4    200×8 | <b>ZF1617RN</b><br>200×6, 带刻度                   | <b>ZF1622RN</b><br>200×6, 带刻度                 |   |
|  |  | <b>ZF466RN</b><br>200×4                         | <b>ZF1618RN</b><br>200×8, 带刻度                   | <b>ZF1623RN</b><br>200×8, 带刻度                 |   |
|  |  |   | <b>ZF1619RN</b><br>200×10, 带刻度                  | <b>ZF1624RN</b><br>200×10, 带刻度                |   |



- |                                       |   |
|---------------------------------------|---|
| 脑吸引管<br>brain suction<br>tube, curved | 脑吸引管<br>brain suction tube, straight                        |
| <b>ZF1458R</b><br>200×Φ1.5, 弯         | <b>ZF1452R</b><br>240×Φ3.5, 直                               |
| <b>ZF1460R</b><br>200×Φ2, 弯           | <b>ZF999R</b> <b>ZF1452RN</b><br>200×Φ2, 直    240×Φ3.5, 直   |
| <b>ZF1461R</b><br>200×Φ2.5, 弯         | <b>ZF1354R</b> <b>ZF1453R</b><br>200×Φ2.5, 直    240×Φ4, 直   |
| <b>ZF1001R</b><br>200×Φ3, 弯           | <b>ZF1354RN</b> <b>ZF1453RN</b><br>200×Φ2.5, 直    240×Φ4, 直 |
| <b>ZF1462R</b><br>200×Φ3.5, 弯         | <b>ZF920R</b> <b>ZF1454R</b><br>200×Φ3    240×Φ4.5, 直       |
| <b>ZF1002R</b><br>200×Φ4, 弯           | <b>ZF1355R</b> <b>ZF1455R</b><br>200×Φ3.5, 直    240×Φ5, 直   |
| <b>ZF1463R</b><br>200×Φ4.5, 弯         | <b>ZF924R</b> <b>ZF1457R</b><br>200×Φ4, 直    260×Φ1.5, 直    |
| <b>ZF922R</b><br>200×Φ5, 弯            | <b>ZF1356R</b> <b>ZF1000R</b><br>200×Φ4.5, 直    260×Φ2, 直   |
| <b>ZF922RN</b><br>200×Φ5              | <b>ZF1003R</b> <b>ZF1000RN</b><br>200×Φ5, 直    260×Φ2, 直    |
| <b>ZF1459R</b><br>260×Φ1.5, 弯         | <b>ZF1357R</b> <b>ZF1008R</b><br>200×Φ6    260×Φ2.5, 直      |
| <b>ZF1464R</b><br>260×Φ2, 弯           | <b>ZF1307R</b> <b>ZF1008RN</b><br>230×Φ3    260×Φ2.5, 直     |
| <b>ZF1465R</b><br>260×Φ2.5, 弯         | <b>ZF1469R</b> <b>ZF921R</b><br>220×Φ1.5, 直    260×Φ3, 直    |
| <b>ZF1004R</b><br>260×Φ3, 弯           | <b>ZF1470R</b> <b>ZF921RN</b><br>220×Φ2, 直    260×Φ3        |
| <b>ZF1466R</b><br>260×Φ3.5, 弯         | <b>ZF1471R</b> <b>ZF1005R</b><br>220×Φ2.5, 直    260×Φ4, 直   |
| <b>ZF1006R</b><br>260×Φ4, 弯           | <b>ZF1472R</b> <b>ZF1005RN</b><br>220×Φ3, 直    260×Φ4, 直    |
| <b>ZF1467R</b><br>260×Φ4.5, 弯         | <b>ZF1473R</b> <b>ZF1009R</b><br>220×Φ3.5, 直    260×Φ3.5, 直 |
| <b>ZF923R</b><br>260×Φ5, 弯            | <b>ZF1474R</b> <b>ZF1468R</b><br>220×Φ4, 直    260×Φ4.5, 直   |
| <b>ZF923RN</b><br>260×Φ5              | <b>ZF1475R</b> <b>ZF883R</b><br>220×Φ4.5, 直    260×Φ5, 直    |
|                                       | <b>ZF1476R</b><br>220×Φ5, 直                                 |
|                                       | <b>ZF1448R</b><br>240×Φ1.5, 直                               |
|                                       | <b>ZF1449R</b><br>240×Φ2, 直                                 |
|                                       | <b>ZF1450R</b><br>240×Φ2.5, 直                               |
|                                       | <b>ZF1451R</b><br>240×Φ3, 直                                 |



Neuro Instruments  
神经外科

直脑吸引管  
brain suction  
tube, straight

- ZF899RG 210×Φ5, 双控孔
- ZF899RN 210×Φ5, 双控孔
- ZF891RG 220×Φ1.5, 双控孔
- ZF891RN 220×Φ1.5, 双控孔
- ZF892RG 220×Φ2, 双控孔
- ZF892RN 220×Φ2, 双控孔
- ZF893RG 220×Φ2.5, 双控孔
- ZF893RN 220×Φ2.5, 双控孔
- ZF894RG 220×Φ3, 双控孔
- ZF894RN 220×Φ3, 双控孔
- ZF895RG 220×Φ3.5, 双控孔
- ZF895RN 220×Φ3.5, 双控孔
- ZF896RG 220×Φ4, 双控孔
- ZF896RN 220×Φ4, 双控孔
- ZF897RG 240×Φ1.5, 双控孔
- ZF897RN 240×Φ1.5, 双控孔
- ZF898RG 230×Φ3, 双控孔
- ZF898RN 230×Φ3, 双控孔

脑吸引管  
brain suction  
tube, straight  
malleable

- ZF1315R 200×Φ2 斜口, 柔性
- ZF1316R 200×Φ2.5 斜口, 柔性
- ZF1317R 200×Φ3 斜口, 柔性
- ZF1318R 200×Φ3.5 斜口, 柔性
- ZF1319R 200×Φ4 斜口, 柔性
- ZF1320R 200×Φ4.5 斜口, 柔性
- ZF1007R 200×Φ5 斜口, 柔性

脑吸引管  
brain suction  
tube, straight  
malleable

- ZF1321R 260×Φ2 斜口, 柔性
- ZF1322R 260×Φ2.5 斜口, 柔性
- ZF1323R 260×Φ3 斜口, 柔性
- ZF1324R 260×Φ3.5 斜口, 柔性
- ZF1325R 260×Φ4 斜口, 柔性
- ZF1326R 260×Φ4.5 斜口, 柔性
- ZF1327R 260×Φ5 斜口, 柔性

直脑吸引管  
brain suction  
tube, straight

- ZF1629R 200×Φ1.5
- ZF1601R 200×Φ2
- ZF1602R 200×Φ2.5
- ZF1603R 200×Φ3
- ZF1604R 200×Φ3.5
- ZF1577R 200×Φ4
- ZF1578R 200×Φ4.5
- ZF1579R 200×Φ5
- ZF1630R 220×Φ1.5
- ZF1580R 220×Φ2
- ZF1581R 220×Φ2.5
- ZF1582R 220×Φ3
- ZF1583R 220×Φ3.5
- ZF1584R 220×Φ4
- ZF1585R 220×Φ4.5
- ZF1586R 220×Φ5
- ZF1631R 240×Φ1.5
- ZF1587R 240×Φ2
- ZF1588R 240×Φ2.5
- ZF1589R 240×Φ3
- ZF1590R 240×Φ3.5
- ZF1591R 240×Φ4
- ZF1592R 240×Φ4.5
- ZF1593R 240×Φ5
- ZF1632R 260×Φ1.5
- ZF1594R 260×Φ2
- ZF1595R 260×Φ2.5
- ZF1596R 260×Φ3
- ZF1597R 260×Φ3.5
- ZF1598R 260×Φ4
- ZF1599R 260×Φ4.5
- ZF1600R 260×Φ5

可控吸引管  
suction tube  
curved  
malleable

- ZF1880RN 180×Φ1.5 弯, 锥度
- ZF1881RN 180×Φ2 弯, 锥度
- ZF1882RN 180×Φ2.5 弯, 锥度
- ZF1883RN 220×Φ1.5 直, 锥度
- ZF1884RN 220×Φ2 直, 锥度
- ZF1885RN 220×Φ2.5 直, 锥度
- ZF1886RN 260×Φ1.5 直, 锥度
- ZF1887RN 260×Φ2 直, 锥度
- ZF1888RN 260×Φ2.5 直, 锥度

可控脑吸引管  
suction tube  
flexible

- ZF1389R 215×Φ1.2
- ZF1389RN 215×Φ1.2
- ZF1390R 215×Φ1.5
- ZF1390RN 215×Φ1.5
- ZF873RN 215×Φ2
- ZF874RN 215×Φ2.5
- ZF875RG 215×Φ3
- ZF875RN 215×Φ3
- ZF1391R 215×Φ3.5
- ZF1391RN 215×Φ3.5
- ZF876RG 215×Φ4
- ZF876RN 215×Φ4
- ZF1392R 215×Φ4.5
- ZF1392RN 215×Φ4.5
- ZF877RG 215×Φ5
- ZF877RN 215×Φ5
- ZF1394R 215×Φ6
- ZF1394RN 215×Φ6

可控吸引管  
suction tube, flexible

- ZF1328RN 220×Φ1.5, 缩口
- ZF1329RN 220×Φ2, 缩口
- ZF1330RN 220×Φ2.5, 缩口
- ZF1331RN 220×Φ3, 缩口
- ZF1332RN 220×Φ3.5, 缩口
- ZF1333RN 220×Φ4, 缩口
- ZF1334RN 250×Φ1.5, 缩口
- ZF1335RN 250×Φ2, 缩口
- ZF1336RN 250×Φ2.5, 缩口
- ZF1337RN 250×Φ3, 缩口
- ZF1338RN 250×Φ3.5, 缩口
- ZF1339RN 250×Φ4, 缩口

可控脑吸引管  
suction tube  
flexible

- ZF862RN 200×Φ3
- ZF863RN 200×Φ5 弯
- ZF864RN 240×Φ3
- ZF865RN 240×Φ5 弯
- ZF986RN 240×Φ2
- ZF987RN 240×Φ4

可控吸引管  
suction tube  
flexible

- ZF1340RG 270×Φ1.2, 缩口
- ZF1340RN 270×Φ1.2, 缩口
- ZF1341RG 270×Φ1.5, 缩口
- ZF1341RN 270×Φ1.5, 缩口
- ZF1342RG 270×Φ2, 缩口
- ZF1342RN 270×Φ2, 缩口
- ZF1343RG 270×Φ2.5, 缩口
- ZF1343RN 270×Φ2.5, 缩口
- ZF1344RG 270×Φ3, 缩口
- ZF1344RN 270×Φ3, 缩口
- ZF1345RG 270×Φ3.5, 缩口
- ZF1345RN 270×Φ3.5, 缩口
- ZF1346RG 270×Φ4, 缩口
- ZF1346RN 270×Φ4, 缩口
- ZF1347RN 270×Φ5, 缩口
- ZF1386RN 270×Φ4.5, 缩口
- ZF1388RN 270×Φ6, 缩口

可控吸引管  
suction tube, flexible

- ZF965RN 270×Φ1.2, 带套
- ZF937RG 270×Φ1.5, 带套
- ZF937RN 270×Φ1.5, 带套
- ZF938RG 270×Φ2, 带套
- ZF938RN 270×Φ2, 带套
- ZF939RG 270×Φ2.5, 带套
- ZF939RN 270×Φ2.5, 带套
- ZF940RG 270×Φ3, 带套
- ZF940RN 270×Φ3, 带套
- ZF941RG 270×Φ3.5, 带套
- ZF941RN 270×Φ3.5, 带套
- ZF942RG 270×Φ4, 带套
- ZF942RN 270×Φ4, 带套
- ZF943RG 270×Φ4.5, 带套
- ZF943RN 270×Φ4.5, 带套
- ZF944RN 270×Φ4.5, 带套
- ZF945RN 270×Φ5, 带套
- ZF2470RN 240×Φ1.2, 带套
- ZF2471RN 240×Φ1.5, 带套
- ZF2472RN 240×Φ2, 带套
- ZF2473RN 240×Φ2.5, 带套
- ZF2474RN 240×Φ3, 带套
- ZF2475RN 240×Φ3.5, 带套
- ZF2476RN 240×Φ4, 带套
- ZF2477RN 240×Φ4.5, 带套
- ZF2478RN 240×Φ5, 带套

可控脑吸引管 ZF879RN (整套编码)  
suction tube set including 2 handles and 9 tubes



ZF978RN 弯柄

ZF972RN  $\Phi 3$

ZF967RN 直柄

ZF973RN  $\Phi 3.5$

ZF968RN  $\Phi 1.2$

ZF974RN  $\Phi 4$

ZF969RN  $\Phi 1.5$

ZF975RN  $\Phi 5$

ZF970RN  $\Phi 2$

ZF976RN  $\Phi 5$

ZF971RN  $\Phi 2.5$



1柄18头带手托可控吸引管 (缩口)  
fine brain spatulas set with hand rest consists of 18 tubes, 3 stylets, and 1 handle

ZF1312RN

直径 $\Phi 1.2, \Phi 1.5, \Phi 2, \Phi 2.5, \Phi 3, \Phi 3.5$ , 管子有效长度80, 100, 120, 缩口, 共18支管, 3支管芯, 1支管柄

Neuro Instruments  
神经外科

细径吸引管  
suction tube

ZF900R  
220 $\times$  $\Phi 1.5$

ZF901R  
220 $\times$  $\Phi 2$

ZF902R  
220 $\times$  $\Phi 2.5$

细径上弯吸引管  
suction tube  
upwards curved

ZF904R  
220 $\times$  $\Phi 2$

ZF905R  
220 $\times$  $\Phi 2.5$

细径下弯吸引管  
suction tube  
downwards curved

ZF906R  
220 $\times$  $\Phi 2$

ZF907R  
220 $\times$  $\Phi 2.5$

直脑吸引管  
brain suction  
tube, straight

ZF1348RG  
220 $\times$  $\Phi 1.5$

斜口, 双控孔  
ZF1349RG  
220 $\times$  $\Phi 2$

斜口, 双控孔  
ZF1350RG  
220 $\times$  $\Phi 2.5$

斜口, 双控孔  
ZF1351RG  
220 $\times$  $\Phi 3$

斜口, 双控孔  
ZF1352RG  
220 $\times$  $\Phi 3.5$

斜口, 双控孔  
ZF1353RG  
220 $\times$  $\Phi 4$

斜口, 双控孔

吸引管  
suction tube

ZF2170RN  
90 $\times$  $\Phi 1.5$

ZF2171RN  
90 $\times$  $\Phi 2$

ZF2172RN  
140 $\times$  $\Phi 2.5$

ZF2173RN  
140 $\times$  $\Phi 3$

双腔吸引管  
suction and irrigation tube

ZF903R  
180 $\times$  $\Phi 2 \times \Phi 2.5$

直型细径吸引管  
suction tube, straight

ZF908R  
220 $\times$  $\Phi 1.5$

Neuro Instruments  
神经外科



神经外科  
Neuro Instruments



吸引针  
suction  
needle

- ZF931R  
123×2.7
- ZF932R  
123×3.2
- ZF933R  
123×3.6

尖头脑针  
puncture  
needle,sharp

- ZF929R



圆头脑针(快速  
钻颅吸引针)  
puncture needle  
straight

- ZF928R  
100×2.5

脑刮匙  
bone curette

- ZK702RGr  
210×3
- ZK703RGr  
210×5
- ZK689RGr  
210×4
- ZK690RGr  
210×6
- ZK691RGr  
210×7

脑刮匙  
bone curette

- ZK694RGr  
250×3
- ZK695RGr  
250×4
- ZK696RGr  
250×5
- ZK697RGr  
250×6
- ZK698RGr  
250×7

脑刮匙  
bone curette

- ZK702R  
210×3
- ZK702RN  
210×3
- ZK703R  
210×5
- ZK703RN  
210×5
- ZK704R  
210×8
- ZK704RN  
210×8

刮匙  
curette

- ZK700R  
250×3
- ZK700RN  
250×3
- ZK701R  
250×8



直型环状刮匙  
curette,flexible

- ZF1572RNr  
210×Φ2
- ZF1573RNr  
210×Φ2.5
- ZF1574RNr  
210×Φ3
- ZF1575RNr  
210×Φ4
- ZF1576RNr  
210×Φ5

直型显微刮匙  
curette,bowl  
shape,flexible

- ZF1560RNr  
210×Φ2,碗形
- ZF1561RNr  
210×Φ3,碗形
- ZF1562RNr  
210×Φ4,碗形
- ZF1563RNr  
210×Φ5,碗形

枪型显微刮匙  
curette,bowl  
shape,flexible

- ZF1566RNr  
240×Φ2,碗形
- ZF1567RNr  
240×Φ3,碗形
- ZF1568RNr  
240×Φ4,碗形
- ZF1569RNr  
240×Φ5,碗形

柔性枪形环状刮匙  
curette,upwards  
curved,flexible

- ZF624RNr  
240×Φ2,上弯
- ZF383RNr  
240×Φ3,上弯
- ZF384RNr  
240×Φ4,上弯
- ZF385RNr  
240×Φ5,上弯

柔性枪形环状刮匙  
curette,left curved  
flexible

- ZF645RNr  
240×Φ2,左弯
- ZF389RNr  
240×Φ3,左弯
- ZF373RNr  
240×Φ4,左弯
- ZF387RNr  
240×Φ5,左弯



神经外科  
Neuro Instruments



Neuro Instruments  
神经外科

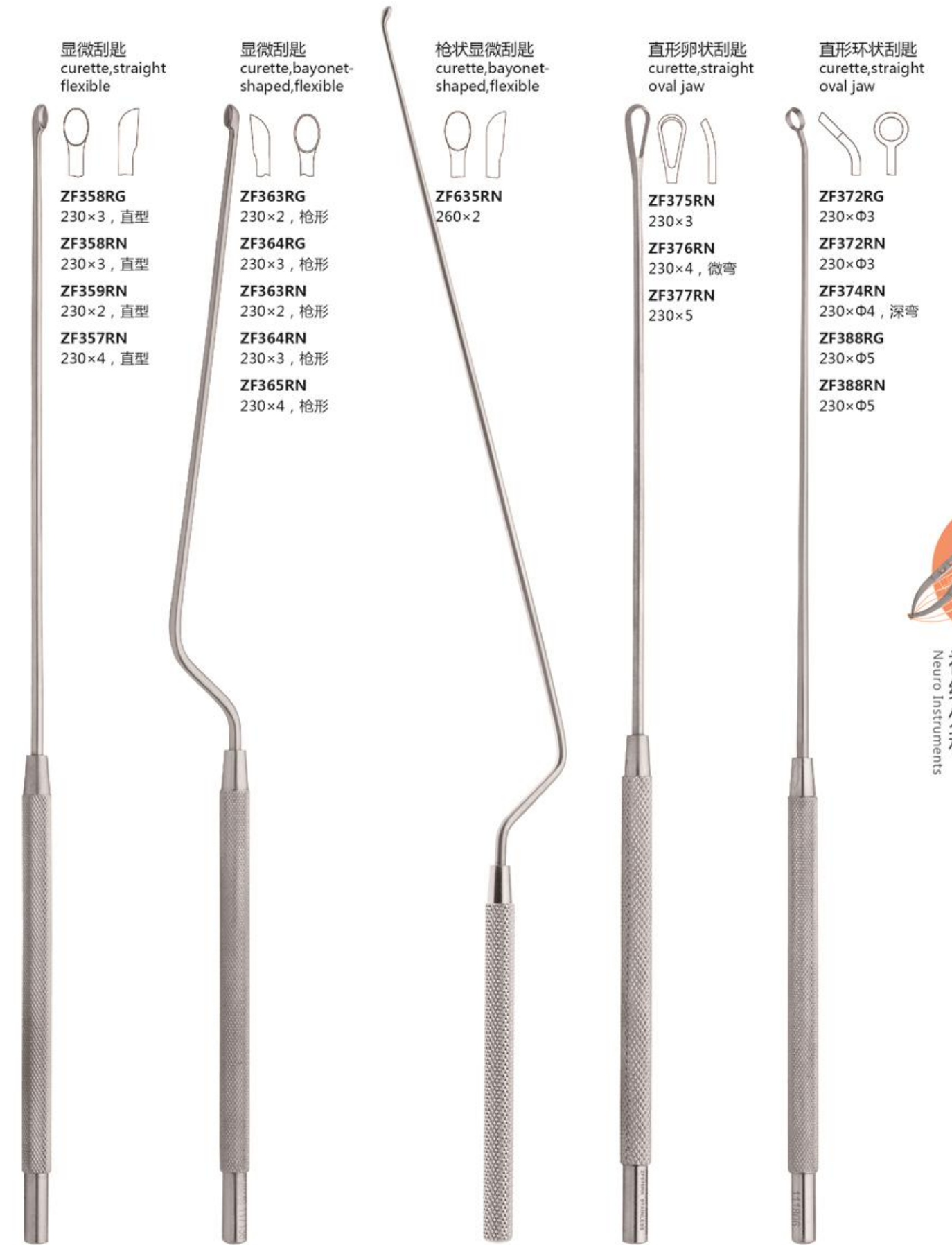

Neuro Instruments  
神经外科





Neuro Instruments  
神经外科

Neuro Instruments  
神经外科

枪形下弯环状刮匙  
curette,downwards  
curved,double edge



- ZF393RN**  
240×Φ3, 双刃
- ZF434RN**  
240×Φ4, 双刃
- ZF457RN**  
240×Φ5, 双刃
- ZF434RNr**  
240×Φ4, 双刃, 柔性
- ZF457RNr**  
240×Φ5, 双刃, 柔性

枪形左弯环状刮匙  
curette,left curved  
double edge



- ZF410RN**  
240×Φ2.5, 双刃
- ZF394RN**  
240×Φ3, 双刃
- ZF411RN**  
240×Φ3.5, 双刃
- ZF412RN**  
240×Φ4, 双刃
- ZF412RNr**, 柔性  
240×Φ4, 双刃
- ZF413RN**  
240×Φ4.5, 双刃
- ZF458RN**  
240×Φ5, 双刃
- ZF414RN**  
240×Φ5.5, 双刃

枪形右弯环状刮匙  
curette,right curved  
double edge



- ZF356RN**  
240×Φ2.5, 双刃
- ZF392RN**  
240×Φ3, 双刃
- ZF398RN**  
240×Φ3.5, 双刃
- ZF399RN**  
240×Φ4, 双刃
- ZF408RN**  
240×Φ4.5, 双刃
- ZF459RN**  
240×Φ5, 双刃
- ZF409RN**  
240×Φ5.5, 双刃

直形环状刮匙  
curette,straight  
ring jaw



- ZF390RG**  
230×Φ3, 双刃
- ZF390RN**  
230×Φ3, 双刃
- ZF391RN**  
230×Φ4, 双刃

枪形钝角环状刮匙  
curette,bayonet-shape  
upwards angled  
double edge



- ZF397RN**  
260×Φ2.5, 双刃

枪形下弯直角  
环状刮匙  
curette,downwards  
curved,ring angle



- ZF1081RN**  
240×Φ2
- ZF1083RN**  
240×Φ3
- ZF1085RN**  
240×Φ4

枪形直角环状刮匙  
curette,bayonet-shape  
right angle



- ZF395RN**  
260×Φ2.5, 双刃
- ZF396RN**  
260×Φ4, 双刃

直型镰刀形显微手术刀  
micro vessel knife



- ZF1547RN**  
210×5.6×45° (5.6为弦长)

直型半月形显微手术刀  
micro vessel knife



- ZF1545RN**  
210×3.8×16° (3.8为弦长)

Neuro Instruments  
神经外科

Neuro Instruments  
神经外科



Neuro Instruments  
神经外科



Neuro Instruments  
神经外科

平骨凿  
bone chisel



ZK127R  
180×4  
ZK127RN  
180×4



平骨凿  
bone chisel



ZK059RN  
200×3, 直形  
方柄  
ZK060RN  
200×5, 直形  
方柄  
ZK121RN  
200×4  
ZK121RG  
200×4



半圆骨凿  
bone gouge



ZK063RN  
200×3, 直形  
方柄  
ZK064RN  
200×4, 直形  
方柄  
ZK065RN  
200×5, 直形  
方柄



月牙骨凿  
bone gouge

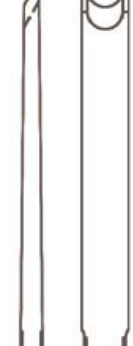

ZK067RN  
200×4, 直形  
方柄  
ZK068RN  
200×5, 直形  
方柄  
ZK069RN  
200×5, 直形  
方柄



枪形平骨凿  
bone chisel  
bayonet-shaped



ZK123RG  
200×5  
ZK123RN  
200×5



枪形半圆平骨凿  
bone gouge  
bayonet-shaped



ZK125RG  
200×5  
ZK125RN  
200×5



枪型半圆骨凿  
bone gouge,  
bayonet-shaped



ZK129RN  
180×5



枪型平骨凿  
bone chisel  
bayonet-shaped



ZK131R  
180×5  
ZK131RN  
180×5



平骨凿  
bone chisel  
bayonet-shaped



ZK061RN  
200×3  
枪形, 方柄  
ZK062RN  
200×4  
枪形, 方柄



半圆骨凿  
bone gouge  
bayonet-shaped



ZK066RN  
200×4  
枪形, 方柄



Neuro Instruments  
神经外科

Neuro Instruments  
神经外科

枪型半圆凿  
bone gouge  
bayonet-shaped

枪形半圆平骨凿  
bone gouge  
bayonet-shaped

枪形月牙骨凿  
bone gouge  
bayonet-shaped

枪型月牙骨凿  
bone gouge  
bayonet-shaped

平骨凿  
bone chisel

半圆骨凿  
bone gouge

月牙骨凿  
bone gouge

平骨凿  
bone chisel  
bayonet-shaped

半圆骨凿  
bone gouge  
bayonet-shaped

月牙骨凿  
bone gouge  
bayonet-shaped

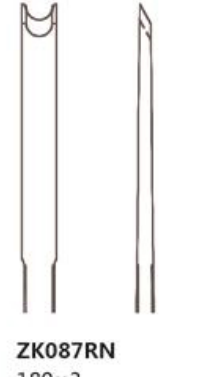
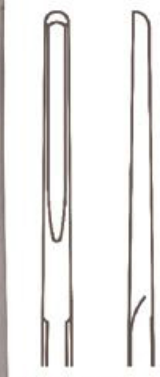

ZK128R  
180×3  
ZK129R  
180×5

ZK124RG  
200×3  
ZK124RN  
200×3

ZK070RN  
200×3, 枪形, 方柄  
ZK071RN  
200×4, 枪形, 方柄  
ZK133R  
200×5  
ZK133RN  
200×5  
ZK133RG  
200×5

ZK130R  
180×4  
ZK130RN  
180×4

ZK072RN  
180×3, 直形, 圆柄  
ZK073RN  
180×4, 直形, 圆柄  
ZK074RN  
180×5, 直形, 圆柄

ZK075RN  
180×3  
直形, 圆柄  
ZK076RN  
180×4  
直形, 圆柄  
ZK077RN  
180×5  
直形, 圆柄

ZK078RN  
180×3  
直形, 圆柄  
ZK079RN  
180×4  
直形, 圆柄  
ZK080RN  
180×5  
直形, 圆柄

ZK081RN  
180×3  
枪形, 圆柄  
ZK082RN  
180×4  
枪形, 圆柄  
ZK083RN  
180×5  
枪形, 圆柄

ZK084RN  
180×3  
枪形, 圆柄  
ZK085RN  
180×4  
枪形, 圆柄  
ZK086RN  
180×5  
枪形, 圆柄

ZK087RN  
180×3  
枪形, 圆柄  
ZK088RN  
180×4  
枪形, 圆柄  
ZK089RN  
180×5  
枪形, 圆柄



Neuro Instruments  
神经外科

Neuro Instruments  
神经外科

Neuro Instruments  
神经外科

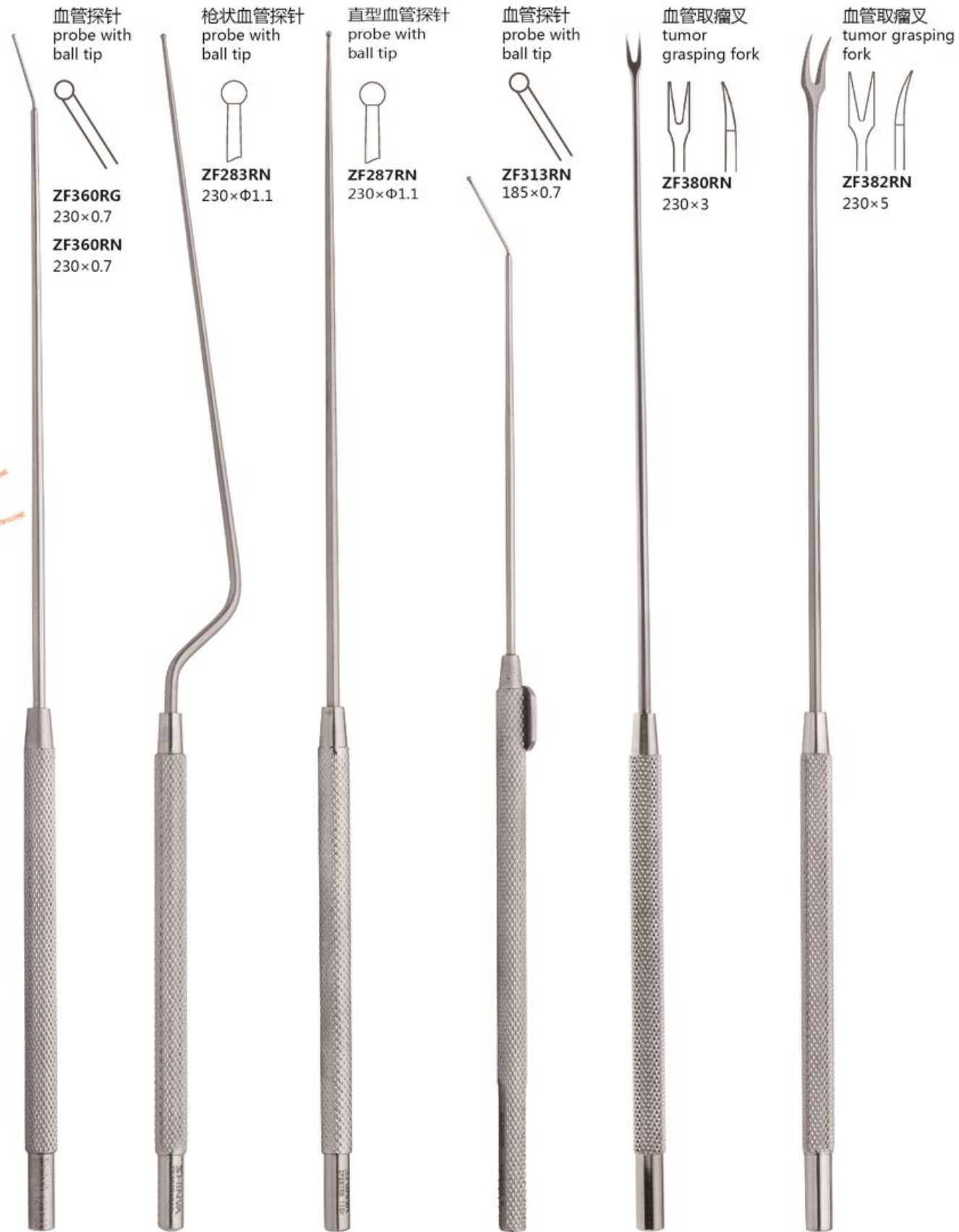

鼻孔撑开钳  
nasal retractors

ZF1376RN 180×70×8  
ZF1377RN 180×80×11  
ZF1378RN 180×90×11



垂体窥镜  
pituitary speculum

ZF544RN 70×8, 无齿, 内收口  
ZF545RN 80×11, 无齿, 内收口  
ZF546RN 90×11, 无齿, 内收口



垂体窥镜  
pituitary speculum

ZF547RN 70×8, 无齿, 右翻左收  
ZF548RN 80×11, 无齿, 右翻左收  
ZF549RN 90×11, 无齿, 右翻左收



垂体窥镜  
pituitary speculum

ZF956RG 70×8, 无齿, 双外翻  
ZF956RN 70×8, 无齿, 双外翻  
ZF947RG 70×13, 无齿, 双外翻  
ZF947RN 70×13, 无齿, 双外翻  
ZF295RN 70×11, 无齿, 外翻口



垂体窥镜  
Mouth Mirrors

ZF957RG 80×11, 无齿, 双外翻  
ZF957RN 80×11, 无齿, 双外翻  
ZF948RG 80×13, 无齿, 双外翻  
ZF948RN 80×13, 无齿, 双外翻

Neuro Instruments  
神经外科



垂体窥镜  
pituitary speculum  
**ZF958RG**  
90×11, 无齿, 双外翻  
**ZF958RN**  
90×11, 无齿, 双外翻  
**ZF949RG**  
90×13, 无齿, 双外翻  
**ZF949RN**  
90×13, 无齿, 双外翻



垂体窥镜  
pituitary speculum  
**ZF950RG**  
70×13, 有齿, 双外翻  
**ZF950RN**  
70×13, 有齿, 双外翻



垂体窥镜  
pituitary speculum  
**ZF951RN**  
85×13, 有齿, 双外翻



垂体窥镜  
pituitary speculum  
**ZF952RN**  
90×13, 有齿, 双外翻



垂体窥镜  
pituitary speculum  
**ZF296RN**  
70×8, 无齿, 左翻右收  
**ZF297RN**  
80×11, 无齿, 左翻右收  
**ZF298RN**  
90×11, 无齿, 左翻右收



垂体窥镜  
pituitary speculum  
**ZF295RNh**  
70×11, 无齿, 外翻口  
**ZF948RNh**  
80×13, 无齿, 双外翻

脑膜镊  
adlerkreuz  
tissue forceps



**ZD735R**  
200×1×2, 大柄花  
**ZD735RN**  
200×1×2, 大柄花



脑部直形解剖镊  
cushing delicate  
dissecting forceps



**ZD239R**  
200  
**ZD239RN**  
200



脑部直形解剖镊  
cushing delicate  
dissecting forceps



**ZD240RN**  
200, 大柄花



脑膜镊  
adlerkreuz  
tissue forceps

**ZD736R**  
200×2×3  
**ZD736RN**  
200×2×3





Neuro Instruments  
神经外科



Neuro Instruments  
神经外科







Neuro Instruments  
神经外科



Neuro Instruments  
神经外科

枪状显微镊(无齿)  
micro dissecting  
forceps

枪形取瘤镊  
tumor grasping  
forceps, jaws  
bayonet-shaped



**ZF843RG**  
215×0.6×120°  
**ZF844RG**  
225×0.6×120°

**ZD313RG**  
225×3×120°



侧弯缝合结扎镊  
suture forceps, curved

**ZF265R**  
125  
**ZF266R**  
160  
**ZF267R**  
200

直型缝合结扎镊  
suture forceps, straight

**ZF260R**  
125  
**ZF260RN**  
125  
**ZF261R**  
160  
**ZF261RN**  
160  
**ZF262R**  
200

枪状垂体瘤镊  
tumour grasping  
forceps, upwards  
curved

枪状垂体瘤镊  
tumour grasping  
forceps, downwards  
curved

枪状垂体瘤镊  
tumour grasping  
forceps, straight

**ZF1212RN**  
180×2, 上弯  
**ZF1213RN**  
180×3, 上弯  
**ZF1214RN**  
180×4, 上弯  
**ZF1215RN**  
180×5, 上弯  
**ZF1216RN**  
200×2, 上弯  
**ZF1217RN**  
200×3, 上弯  
**ZF1218RN**  
200×4, 上弯  
**ZF1219RN**  
200×5, 上弯  
**ZF1220RN**  
225×2, 上弯  
**ZF1221RN**  
225×3, 上弯  
**ZF1222RN**  
225×4, 上弯  
**ZF1223RN**  
225×5, 上弯  
**ZF219G**  
240×2, 上弯  
**ZF219RN**  
240×2, 上弯  
**ZF220RN**  
240×3, 上弯  
**ZF221RG**  
240×4  
**ZF221RN**  
240×4, 上弯  
**ZF1224RN**  
240×5, 上弯

**ZF1225RN**  
180×2, 下弯  
**ZF1226RN**  
180×3, 下弯  
**ZF1227RN**  
180×4, 下弯  
**ZF1228RN**  
180×5, 下弯  
**ZF1229RN**  
200×2, 下弯  
**ZF1230RN**  
200×3, 下弯  
**ZF1231RN**  
200×4, 下弯  
**ZF1232RN**  
200×5, 下弯  
**ZF1233RN**  
225×2, 下弯  
**ZF1234RN**  
225×3, 下弯  
**ZF1235RN**  
225×4, 下弯  
**ZF1236RN**  
225×5, 下弯  
**ZF222RG**  
240×2, 下弯  
**ZF222RN**  
240×2, 下弯  
**ZF223RG**  
240×3, 下弯  
**ZF223RN**  
240×3, 下弯  
**ZF224RN**  
240×4, 下弯  
**ZF1237RN**  
240×5, 下弯

**ZF1199RN**  
180×2, 直型  
**ZF1200RN**  
180×3, 直型  
**ZF1201RN**  
180×4, 直型  
**ZF1202RN**  
180×5, 直型  
**ZF1203RN**  
200×2, 直型  
**ZF1204RN**  
200×3, 直型  
**ZF1205RN**  
200×4, 直型  
**ZF1206RN**  
200×5, 直型  
**ZF1207RN**  
225×2, 直型  
**ZF1208RN**  
225×3, 直型  
**ZF1209RN**  
225×4, 直型  
**ZF1210G**  
225×5, 直型  
**ZF1210RN**  
225×5, 直型  
**ZF216RG**  
240×2, 直头  
**ZF216RN**  
240×2, 直头  
**ZF217RG**  
240×3, 直型  
**ZF217RN**  
240×3, 直头  
**ZF218RN**  
240×4, 直头  
**ZF1211RN**  
240×5, 直型

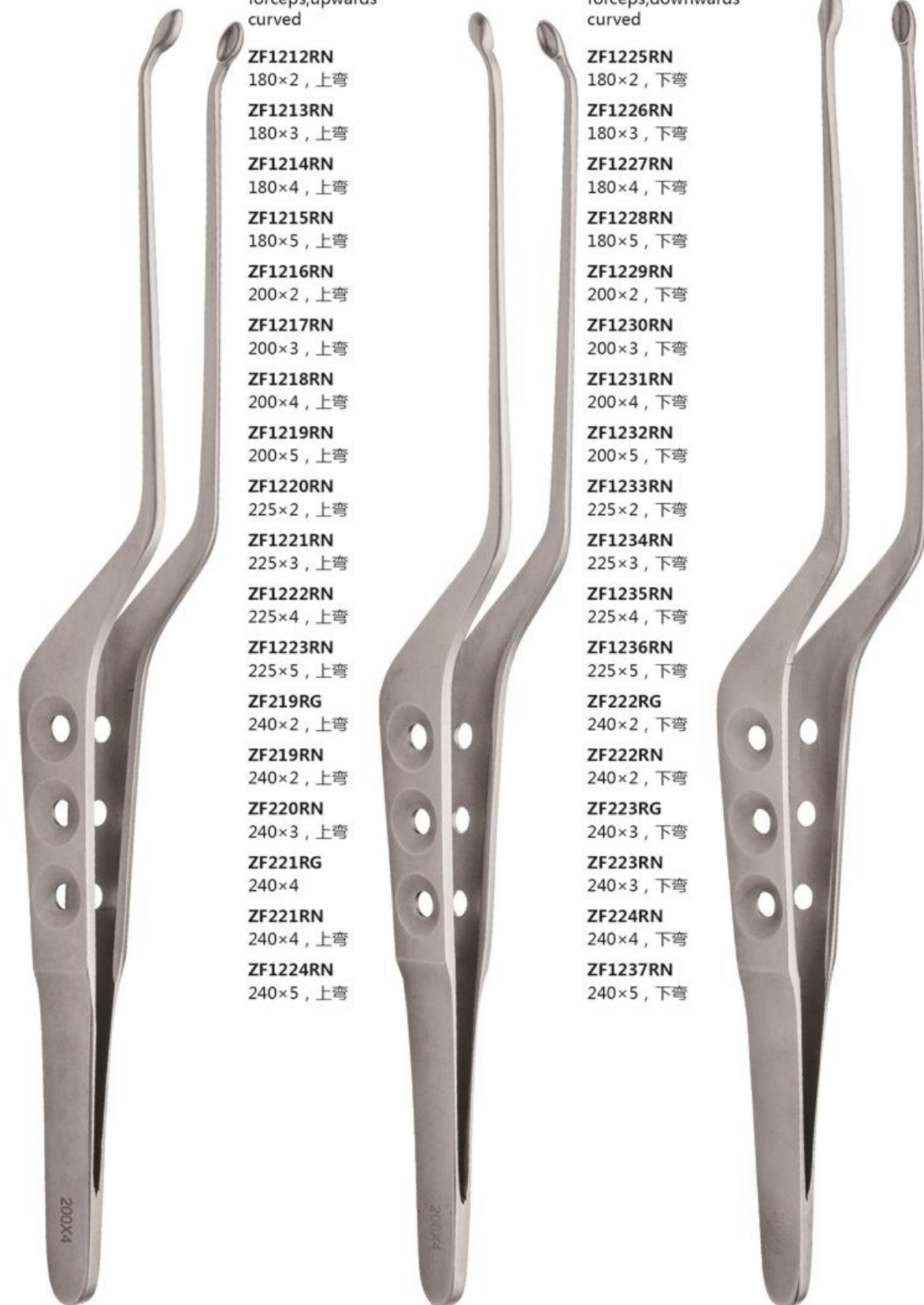



Neuro Instruments  
神经外科



枪状有齿取瘤镊  
tumour grasping  
forceps, curette jaw  
serreted

**ZF206RG**  
240×3

**ZF206RN**  
240×3



枪状有齿取瘤镊  
tumour grasping  
forceps, curette jaw  
serreted

**ZF207RG**  
240×5

**ZF207RN**  
240×5



枪状环形齿镊  
tumour grasping  
forceps, flat jaws  
serrated

**ZF1185RN**  
180×2

**ZF1186RN**  
180×3

**ZF1187RN**  
180×4

**ZF1188RN**  
180×5

**ZF1189RN**  
200×2

**ZF1190RN**  
200×3

**ZF1191RN**  
200×4

**ZF1192RN**  
200×5

**ZF1193RN**  
225×2

**ZF1194RN**  
225×3

**ZF1195RN**  
225×4

**ZF1196RN**  
225×5

**ZF1197RN**  
240×2

**ZF1198RN**  
240×4

**ZF204RN**  
240×3

**ZF205RN**  
240×5



枪状取瘤镊  
tumor grasping  
forceps, jaws  
spoon-shaped

**ZF1171RN**  
180×2

**ZF1172RN**  
180×3

**ZF1173RN**  
180×4

**ZF1174RN**  
180×5

**ZF1175RN**  
200×2

**ZF1176RN**  
200×3

**ZF1177RN**  
200×4

**ZF1178RN**  
200×5

**ZF1179RN**  
225×2

**ZF1180RN**  
225×3

**ZF1181RN**  
225×4

**ZF1182RN**  
225×5

**ZF1183RN**  
240×2

**ZF199RG**  
240×2

**ZF200RG**  
240×3

**ZF200RN**  
240×3

**ZF201RN**  
240×4

**ZF202RG**  
240×5

**ZF202RN**  
240×5



枪状显微镊  
micro forceps  
bayonet-shaped  
smooth jaw

**ZF1238RN**  
180×0.6, 无齿

**ZF1239RN**  
200×0.6, 无齿

**ZF1240RN**  
225×0.6, 无齿

**ZF840RG**  
240×0.6, 无齿

**ZF840RN**  
240×0.6, 无齿



枪状显微镊  
micro forceps  
bayonet-shaped  
serrated

**ZF1241RN**  
180×0.9, 有齿

**ZF1242RN**  
200×0.9, 有齿

**ZF1243RN**  
225×0.9, 有齿

**ZF841RG**  
240×0.9, 有齿

**ZF841RN**  
240×0.9, 有齿



Neuro Instruments  
神经外科

Neuro Instruments  
神经外科

Neuro Instruments  
神经外科



枪状显微组织镊  
micro dressing forceps, bayonet-shaped

**ZF1244RN**  
180×1×2钩

**ZF1245RN**  
200×1×2钩

**ZF1246RN**  
225×1×2钩

**ZF842RG**  
240×1×2钩

**ZF842RN**  
240×1×2钩



枪型组织镊  
micro dressing forceps, bayonet-shaped

**ZD837R**  
210×1×2



直型枪状簧式组织剪  
micro scissors bayonet-shaped straight

**ZF105R**  
185

弯型枪状簧式组织剪  
micro scissors bayonet-shaped curved

**ZF106R**  
185

**ZF106RN**  
185

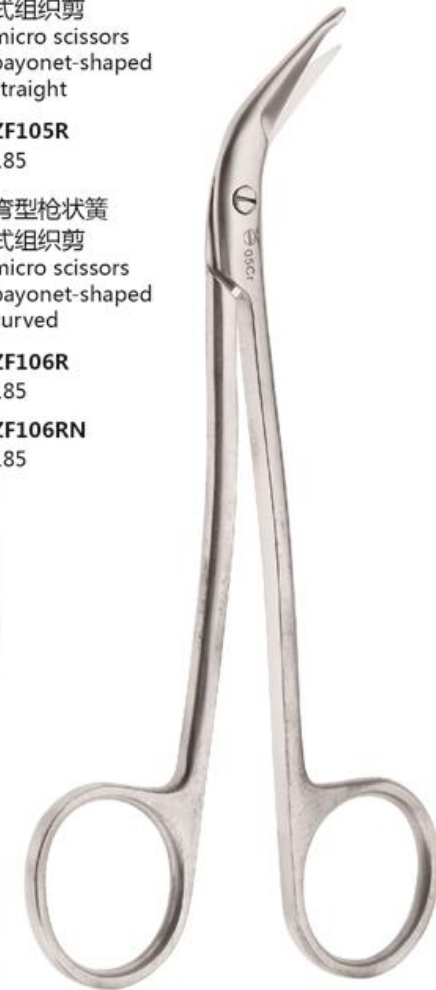

侧弯尖球头脑膜剪  
schmieden-taylor dura scissors sharp/blunt, curved

**ZC660R**  
150

**ZC660RN**  
150



圆弯头脑膜剪  
schmieden-taylor dura scissors, sharp/blunt, curved

**ZC661R**  
180

**ZC661RN**  
180

脑膜剪  
dura scissors

**ZC659R**  
200, 弯

**ZC659RN**  
200, 弯



三叉神经剪  
trigemino scissors

**ZC655R**  
170



枪状簧式组织剪  
micro scissors bayonet-shaped



**ZF034RN**  
200, 尖直, 短头

**ZF035RN**  
200, 上尖弯, 短头

**ZF024RG**  
210×120°, 尖直

**ZF026RG**  
220×120°, 上尖弯

**ZF025RG**  
230×120°, 尖直

**ZF027RG**  
220×120°, 下尖弯



枪状精细簧式组织剪  
micro scissors bayonet-shaped straight



**ZF1400RN**  
180, 直

**ZF1402RN**  
200, 直

**ZF103RN**  
225, 直型

**ZF1404RN**  
240, 直



枪状精细簧式组织剪  
micro scissors  
bayonet-shaped  
curved



- ZF1401RN**  
180, 弯
- ZF1403RN**  
200, 弯
- ZF104RN**  
225, 弯型
- ZF1405RN**  
240, 弯



枪状精细簧式组织剪  
micro scissors  
bayonet-shaped  
curved

- ZF036RN**  
200, 下尖弯  
短头



枪状簧式组织剪  
micro scissors  
bayonet-shaped  
straight



- ZF038RG**  
225, 直型
- ZF038RN**  
225, 直型
- ZF1132RN**  
240, 尖直



枪状簧式组织剪  
micro scissors  
bayonet-shaped  
curved



- ZF1133RN**  
240, 尖弯
- ZF039RN**  
225, 弯型



枪状簧式组织剪  
micro scissors  
bayonet-shaped  
straight



- ZF037RG**  
225, 尖直
- ZF037RN**  
225, 尖头直



枪状簧式组织剪  
micro scissors  
bayonet-shaped  
curved



- ZF040RG**  
225尖弯
- ZF040RN**  
225, 尖头弯



枪状簧式组织剪  
micro scissors  
bayonet-shaped  
curved



- ZF043RN**  
225, 长圆弯



枪状簧式组织剪  
micro scissors  
bayonet-shaped  
straight



- ZF044RN**  
225, 长圆直



枪形组织剪  
micro scissors, bayonet-shaped



- ZF1608RG**  
165, 直, 指圈  
straight
- ZF1610RG**  
180, 左弯, 指圈  
left curved

- ZF1606RG**  
165, 左弯, 指圈  
left curved
- ZF1607RG**  
165, 右弯, 指圈  
right curved

- ZF1611RG**  
180, 右弯, 指圈  
right curved
- ZF1612RG**  
180, 直, 指圈  
straight



- ZF1605RG**  
165, 上弯, 指圈  
upwards curved
- ZF1609RG**  
180, 上弯, 指圈  
upwards curved



枪形精细组织钳  
micro scissors, bayonet-shaped

- ZF623RG**  
165×1.7



精细取瘤钳  
pituitary rongeur



- ZF1013RN**  
160×3, 直长圆头



- ZF1014RN**  
160×3×120°, 上弯长圆头



枪形精细组织钳  
pituitary rongeur 直头  
straight

- F605RN**  
165×2, 直头
- ZF606RN**  
165×3, 直头
- ZF607RN**  
165×4, 直头

- ZF1818RN**  
180×2, 直头
- ZF1821RN**  
180×3, 直头
- ZF1824RN**  
180×4, 直头
- ZF1827RN**  
180×5, 直头

- ZF599RN**  
200×2, 直头
- ZF600RN**  
200×3, 直头
- ZF601RN**  
200×4, 直头
- ZF1010RN**  
200×5, 直头

精细取瘤钳  
pituitary rongeur



右向  
right

ZF609RN	165×3	ZF1820RN	180×2	ZF668RN	200×2
ZF664RN	165×2	ZF1823RN	180×3	ZF603RN	200×3
ZF667RN	165×4	ZF1826RN	180×4	ZF669RN	200×4
		ZF1829RN	180×5	ZF1012RN	200×5



左向  
left

ZF608RN	165×2	ZF1819RN	180×2	ZF602RN	200×2
ZF663RN	165×3	ZF1822RN	180×3	ZF598RN	200×3
ZF600RN	165×4	ZF1825RN	180×4	ZF604RN	200×4
		ZF1828RN	180×5	ZF1011RN	200×5

管式精细取瘤钳  
pituitary rongeur

ZF1810RN	ZF1811RN
200×3, 直, 可转式 rotatable, straight	200×3, 弯, 可转式 rotatable, curved

左向角型取瘤钳  
rongeur, left curved

右向角型取瘤钳  
rongeur, right curved

ZF620R	ZF621R
150×5	150×5

显微组织剪切钳  
tissue cutting forceps

ZF1803RN
180×Φ3
ZF1804RN
180×Φ4

活组织取样钳  
biopsy forceps

ZF625R
150×3
ZF626R
150×6
ZF626RN
150×6

银夹钳  
clip applying forceps  
for angioma silver clips  
ZF885R  
160, 正弯

银夹钳  
clip applying forceps

ZF886R
165, 脑幕

角形银夹钳  
clip applying forceps  
ZF884R  
180

精细椎板咬骨钳  
kerrison punch, thin footplate

ZF1270RNdh	ZF1276RNdh	ZF1282RNdh
180×2×90°, 超薄	200×3×110°, 超薄	180×2×130°, 超薄
ZF1271RNdh	ZF1277RNdh	ZF1283RNdh
200×2×90°, 超薄	180×4×110°, 超薄	200×2×130°, 超薄
ZF1272RNdh	ZF1278RNdh	ZF1284RNdh
180×3×90°, 超薄	200×4×110°, 超薄	180×3×130°, 超薄
ZF1273RNdh	ZF1279RNdh	ZF1285RNdh
200×3×90°, 超薄	180×2×110°, 超薄	200×3×130°, 超薄
ZF1274RNdh	ZF1280RNdh	ZF1286RNdh
180×4×90°, 超薄	200×2×110°, 超薄	180×4×130°, 超薄
ZF1275RNdh	ZF1281RNdh	ZF1287RNdh
200×4×90°, 超薄	180×3×110°, 超薄	200×4×130°, 超薄



精细髓核钳  
laminectomy rongeur

- |                                   |  |  |
|-----------------------------------|--|--|
| <b>ZF1250RNdh</b><br>180×2×6, 握柄式 | <b>ZF1254RNdh</b><br>180×4×8, 握柄式      | <b>ZF1258RNdh</b><br>180×3×7×150°, 握柄式 |
| <b>ZF1251RNdh</b><br>200×2×6, 握柄式 | <b>ZF1255RNdh</b><br>200×4×8, 握柄式      | <b>ZF1259RNdh</b><br>200×3×7×150°, 握柄式 |
| <b>ZF1252RNdh</b><br>180×3×7, 握柄式 | <b>ZF1256RNdh</b><br>180×2×6×150°, 握柄式 | <b>ZF1260RNdh</b><br>180×4×8×150°, 握柄式 |
| <b>ZF1253RNdh</b><br>200×3×7, 握柄式 | <b>ZF1257RNdh</b><br>200×2×6×150°, 握柄式 | <b>ZF1261RNdh</b><br>200×4×8×150°, 握柄式 |



转换式咬骨钳  
rongeur

- |                              |                             |
|------------------------------|-----------------------------|
| <b>ZF657RG</b><br>165×2×130° | <b>ZF655RG</b><br>165×2×90° |
| <b>ZF658RG</b><br>165×3×130° | <b>ZF656RG</b><br>165×3×90° |



转换式咬骨钳  
rongeur

- |                                |
|--------------------------------|
| <b>ZF1106RN</b><br>180×2.5×90° |
| <b>ZF1107RN</b><br>180×3×90°   |
| <b>ZF1108RN</b><br>180×4×90°   |



转换式咬骨钳  
rongeur

- |                                 |
|---------------------------------|
| <b>ZF1110RN</b><br>180×2.5×120° |
| <b>ZF1111RN</b><br>180×3×120°   |
| <b>ZF1112RN</b><br>180×4×120°   |



转换式咬骨钳  
rongeur, rotatable

- |                                     |
|-------------------------------------|
| <b>ZF1115RN</b><br>200×3×90°, 可拆式   |
| <b>ZF1116RN</b><br>200×3.5×90°, 可拆式 |
| <b>ZF1117RN</b><br>200×4×90°, 可拆式   |



转换式咬骨钳  
rongeur, rotatable

- |                                      |
|--------------------------------------|
| <b>ZF1118RN</b><br>200×3×120°, 可拆式   |
| <b>ZF1119RN</b><br>200×3.5×120°, 可拆式 |
| <b>ZF1120RN</b><br>200×4×120°, 可拆式   |



角形组织钳  
tampon forceps

- |                        |
|------------------------|
| <b>ZO243R</b><br>220×3 |
|------------------------|

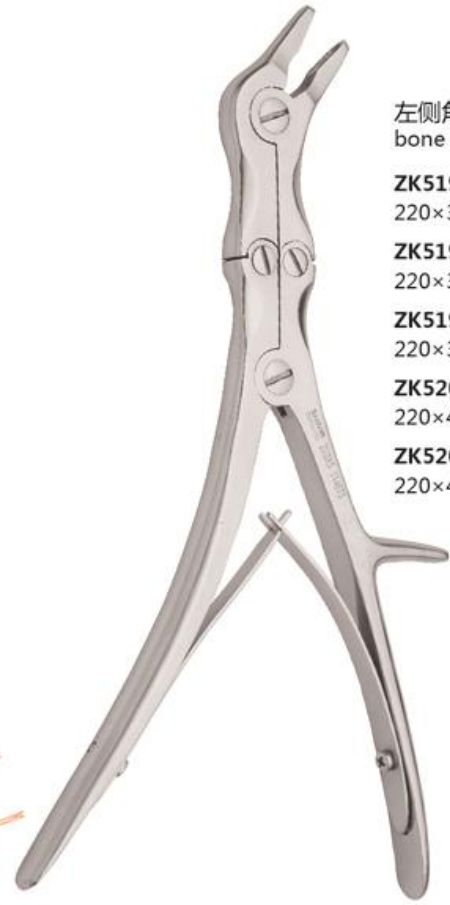

左侧角40°双关节咬骨钳  
bone rongeur

- |                              |                              |
|------------------------------|------------------------------|
| <b>ZK519R</b><br>220×3, 直头   | <b>ZK521R</b><br>220×5, 直头   |
| <b>ZK519RN</b><br>220×3, 直头  | <b>ZK521RN</b><br>220×5, 直头  |
| <b>ZK519RNj</b><br>220×3, 直头 | <b>ZK522R</b><br>220×6, 直头   |
| <b>ZK520R</b><br>220×4, 直头   | <b>ZK522RN</b><br>220×6, 直头  |
| <b>ZK520RN</b><br>220×4, 直头  | <b>ZK522RNj</b><br>220×6, 直头 |



颅骨咬骨钳  
dahlgren skull punch

- ZF113R**  
200



右侧角13°双关节咬骨钳  
bone rongeur

- |                               |                                |
|-------------------------------|--------------------------------|
| <b>ZK504RNj</b><br>240×3, 直头  | <b>ZK527RN</b><br>240×6, 右弯30° |
| <b>ZK505RNj</b><br>240×4, 直头  | <b>ZK532R</b><br>240×8, 直头     |
| <b>ZK506RNj</b><br>240×5, 直头  | <b>ZK532RN</b><br>240×8, 直头    |
| <b>ZK526R</b><br>240×6, 直头    | <b>ZK532RNj</b><br>240×8, 直头   |
| <b>ZK526RNj</b><br>240×6, 直头  | <b>ZK533R</b><br>240×8, 右弯30°  |
| <b>ZK527R</b><br>240×6, 右弯30° | <b>ZK533RN</b><br>240×8, 右弯30° |



左侧角40°双关节咬骨钳  
bone rongeur, left angled 30°

- ZK515R**  
240×2, 左弯30°
- ZK517R**  
240×3, 左弯30°
- ZK523R**  
240×4, 左弯30°



后颅凹咬骨钳  
fossae cranii  
posterior rongeur

- ZK535R**  
205×5.5
- ZK535RN**  
205×5.5



右侧角40°双关节咬骨钳  
frykholm rongeur, angled

- ZK525R**  
240×4, 直头
- ZK525RN**  
240×4, 直头
- ZK525RNj**  
240×4, 直头
- ZK540R**  
240×2, 直头
- ZK562RN**  
240×3, 直头
- ZK562RNj**  
240×3, 直头



左侧角40°双关节咬骨钳  
bone rongeur, left angled 30°

- ZK516R**  
240×2, 右弯30°
- ZK518R**  
240×3, 右弯30°
- ZK524R**  
240×4, 右弯30°



右侧角40°双关节咬骨钳  
bone rongeur, left angled 30°

- ZK542R**  
240×2, 左上弯30°
- ZK546R**  
240×3, 左上弯30°
- ZK546RNj**  
240×3, 左上弯30°
- ZK550R**  
240×4, 左上弯30°



右侧角40°双关节咬骨钳  
bone rongeur, right angled 30°

- ZK544R**  
240×2, 右上弯30°
- ZK548R**  
240×3, 右上弯30°
- ZK548RNj**  
240×3, 右上弯30°
- ZK552R**  
240×4, 右上弯30°
- ZK552RNj**  
240×4, 右上弯30°

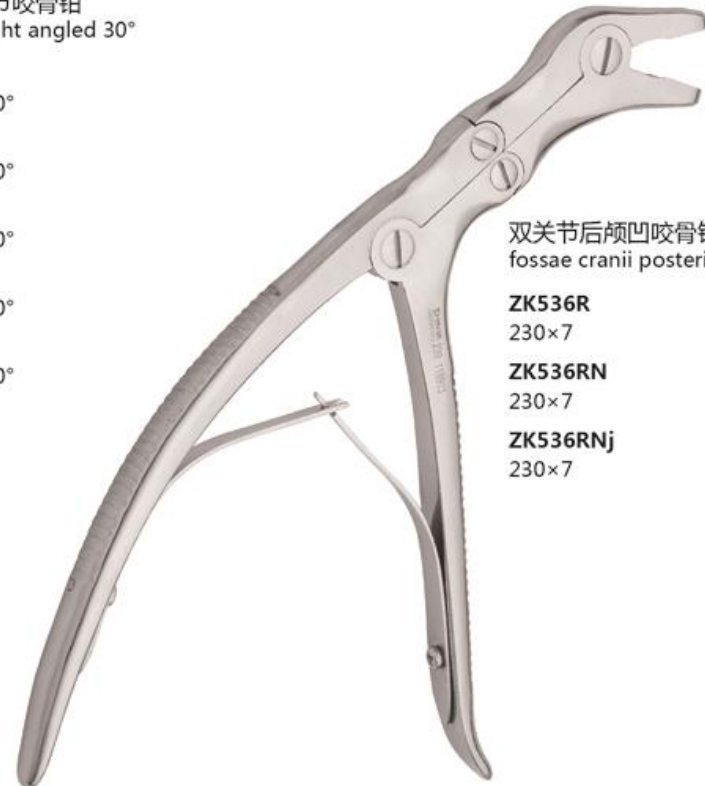

双关节后颅凹咬骨钳  
fossae cranii posterior rongeur

- ZK536R**  
230×7
- ZK536RN**  
230×7
- ZK536RNj**  
230×7



头皮夹钳  
applying forceps  
for scalp clip

- ZF003R**  
160
- ZF003RN**  
160



颅骨钻孔保护钳  
bore holding  
protection forceps

- ZF051R**  
180

头皮夹  
applying forceps for scalp clip

- ZF115R**  
塑料



Neuro Instruments  
神经外科



右侧角90°双关节咬骨钳  
echlin bone rongeur, angled

- ZK556RNj**  
230×3, 直头
- ZK557RN**  
230×4, 直头
- ZK557RNj**  
230×4, 直头
- ZK558RNj**  
230×6, 直头
- ZK559RN**  
230×8, 直头
- ZK559RNj**  
230×8, 直头



双关节咬骨钳  
mayfield bone rongeur, angled

- ZK570R**  
230×3×20°, 弯头
- ZK571R**  
220×4×20°, 弯头



枪状簧式持针钳  
needleholder  
bayonet-shaped

- ZF090R**  
185, 直型  
straight
- ZF090RN**  
185, 直型  
straight
- ZF091R**  
185, 弯型  
curved
- ZF091RN**  
185, 弯型  
curved



自锁簧式持针钳  
micro needleholder  
straight with catch

- ZF092R**  
185 (方柄), 直型



自锁簧式持针钳  
micro needleholder  
curved with catch

- ZF093R**  
185 (方柄), 弯型



自锁簧式持针钳  
micro needleholder  
curved with catch

- ZF049RN**  
200, 弯型 (方柄)
- ZF093RN**  
185 (方柄), 弯型



Neuro Instruments  
神经外科





自锁簧式持针钳  
micro needleholder  
straight with catch  
**ZF092RN**  
185 (方柄), 直型  
**ZF048RN**  
200, 直型 (方柄)



簧式持针钳  
micro needleholder  
straight  
**ZF096RG**  
225直  
**ZF096RN**  
225, 直型  
**ZF098RN**  
200, 直型 (枪状)



簧式持针钳  
micro needleholder  
curved  
**ZF097RG**  
225弯  
**ZF097RN**  
225, 弯型  
**ZF102RN**  
200, 弯型 (枪状)

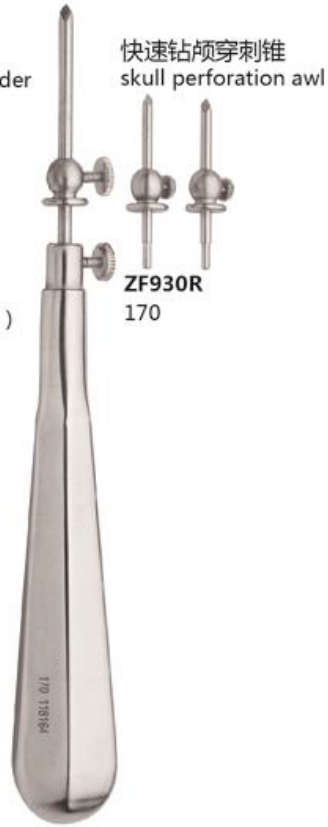

快速钻颅穿刺锥  
skull perforation awl  
**ZF930R**  
170



颈动脉穿刺针  
puncture needle  
straight  
**ZF925R**  
75×1  
**ZF926R**  
75×1.2  
**ZF927R**  
75×1.4



脑室穿刺针 (有刻度)  
ventricular puncture  
needle, graduated  
**ZF912R**  
90×1.8  
**ZF913R**  
90×2.4

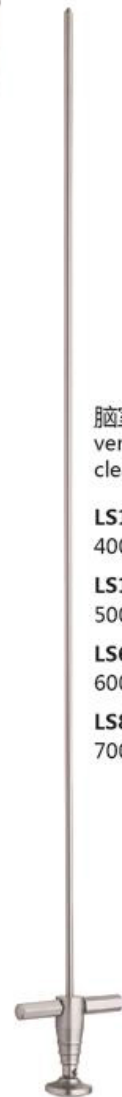

脑室通条  
ventricle  
cleaning rod  
**LS1129R**  
400×Φ4  
**LS1166R**  
500×Φ4  
**LS616R**  
600×Φ4  
**LS836R**  
700×Φ4



银夹  
mc kenzie silver clip  
**ZF880AG**  
100×1



单列银夹台  
mc kenzie clip magazine  
**ZF881R**



脑膜挑针  
dura hook  
**ZF318R**  
150, 锐  
**ZF318RN**  
150, 锐  
**ZF319R**  
150, 钝



沟状探针  
doyen probe  
grooved form  
**ZM010R**  
150  
**ZM010RN**  
150

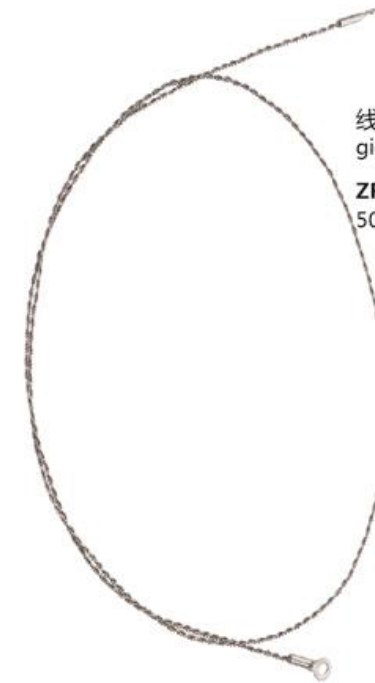

线锯  
gigli saw  
**ZF870R**  
500



线锯手把  
handle for gigli saw  
**ZF872R**



骨锤  
hajek bone  
hammer  
**ZK042RG**  
200/75克



骨锤  
hajek bone  
hammer  
**ZK045RN**  
180/50g  
**ZK046RN**  
180/70g



线锯导板  
conductor  
for gigli saw  
**ZF871R**  
340



骨科钻头  
orthopaedic drill  
**ZF058R**  
Φ10, 开颅



骨科钻头  
orthopaedic drill  
**ZF066R**  
1# (Φ14), 球形  
**ZF067R**  
2# (Φ16), 球形



骨科钻头  
perforators  
**ZF062R**  
1# (头宽12), 扁状  
**ZF063R**  
2# (头宽14), 扁状

骨科钻头  
perforators

- ZF064R**  
80×4.5, 扁状
- ZF065R**  
80×5, 扁状
- ZF070R**  
80×3, 扁状
- ZF071R**  
80×3.5, 扁状
- ZF072R**  
80×4, 扁状

一次成型钻头  
burrs

- ZF059R**  
10×Φ12
- ZF060R**  
12×Φ12
- ZF061R**  
15×Φ12

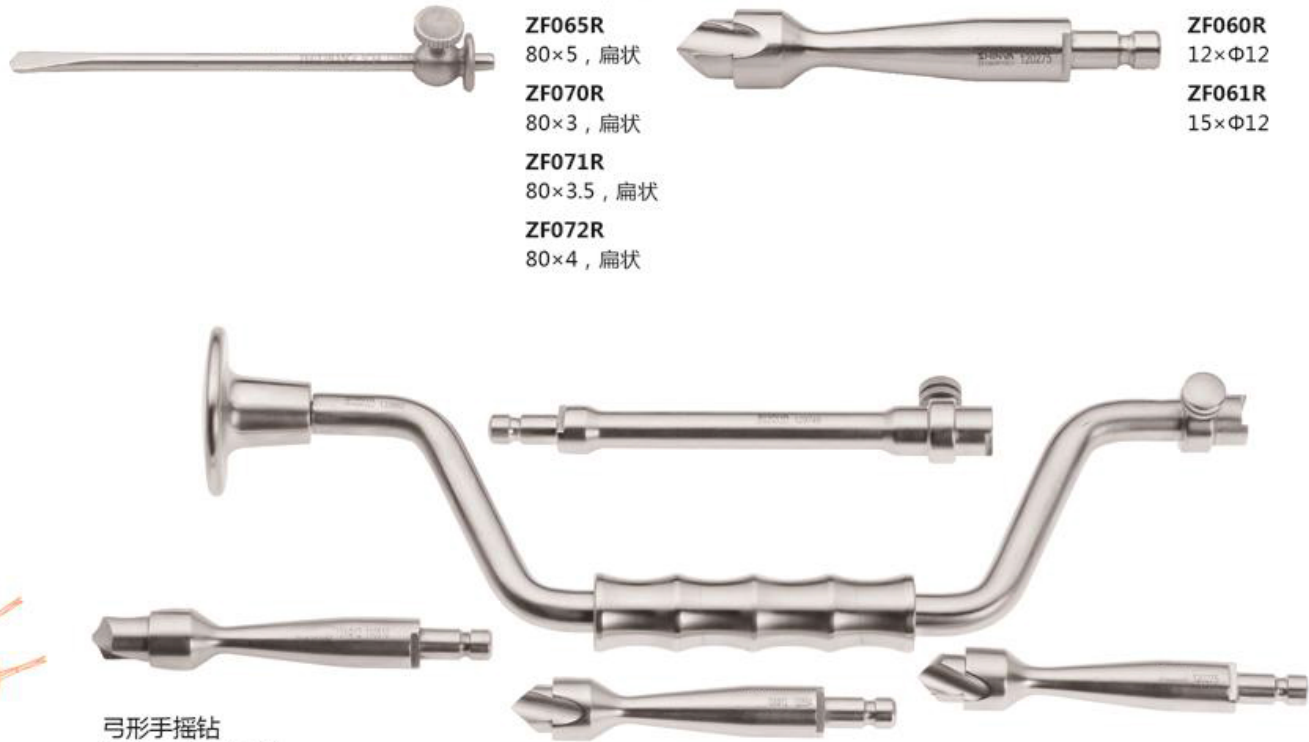

弓形手摇钻  
hudson hand drill

- ZF052R**  
(ZF059R, ZF060R, ZF061R, ZF056R, ZF057R)

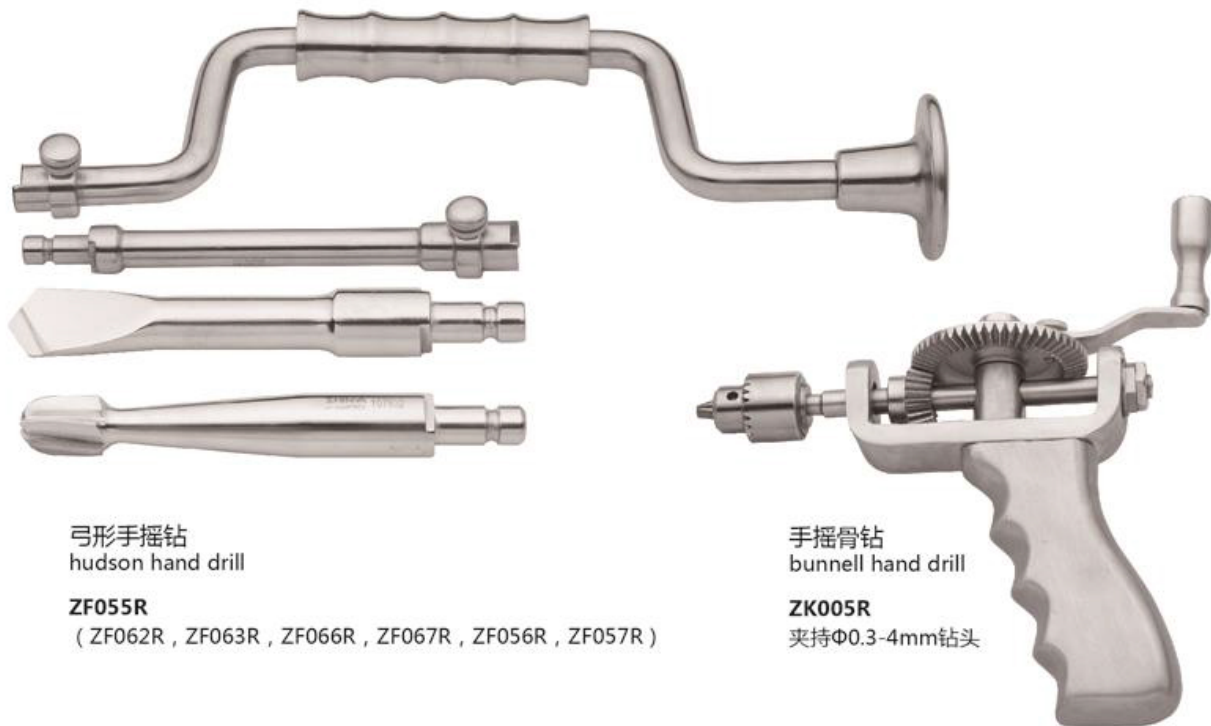

弓形手摇钻  
hudson hand drill

- ZF055R**  
(ZF062R, ZF063R, ZF066R, ZF067R, ZF056R, ZF057R)

手摇骨钻  
bunnell hand drill

- ZK005R**  
夹持Φ0.3-4mm钻头



精细剪  
delicate scissors  
curved, sharp

- JC504RB**  
180, 弯  
尖头, 镶片

精细剪  
delicate scissors  
curved, blunt

- JC505RB**  
180, 弯  
宽头, 镶片

心脏手术剪  
surgical scissors

- JL1800RB**  
180×45°
- JL1801RB**  
180×60°

无损伤镊  
atraumatic forceps

- JL397RB**  
180×1.2
- JL398RB**  
180×1.8



显微镊  
micro forceps  
straight

- JF198RB**  
180×Φ1  
环形

显微镊  
micro forceps  
straight

- JF845RB**  
180×0.6  
直, 平台

显微持针钳  
micro needleholder,  
straight with catch

- JF2440RB**  
210, 直, 自锁, 簧式

显微持针钳  
micro needleholder  
curved with catch

- JF2441RB**  
210, 弯, 自锁, 簧式



Neuro Instruments  
神经外科



骨膜剥离器  
elevator  
double ended

**JK364RB**  
180×1/2, 双头  
**JK365RB**  
180×3/4, 双头



凹凸齿止血夹  
atraumatic clip  
right curved

**JL1368RB**  
110, 右弯



凹凸齿止血夹  
atraumatic clip  
left curved

**JL1367RB**  
110, 左弯



直角钳  
dissecting and  
ligature forceps

**JH230RB**  
130×13  
**JH231RB**  
180×15



主动脉侧壁钳  
peripheral vascular clamp

**JL1400RB**  
160×Φ4  
**JL1401RB**  
190×Φ6



主动脉侧壁钳  
peripheral vascular clamp

**JL1405RB**  
140×20 双齿



主动脉阻断钳  
peripheral vascular clamp

**JL1604RB**  
130×32×45°

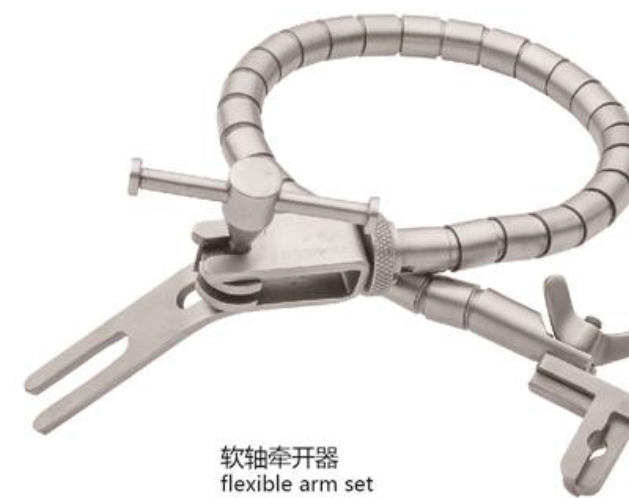

软轴牵开器  
flexible arm set

**ZF1835RN**  
300, 快速锁紧型, 固定夹固定式



软轴牵开器  
flexible arm set

**ZF270RN**  
450×Φ9.5



Neuro Instruments  
神经外科



单臂固定夹  
flexible arm set,  
fixation base for one arm 1 pc  
ZF271RN



双臂固定夹  
flexible arm set,fixation  
base for two arms 2 pc  
ZF272RN

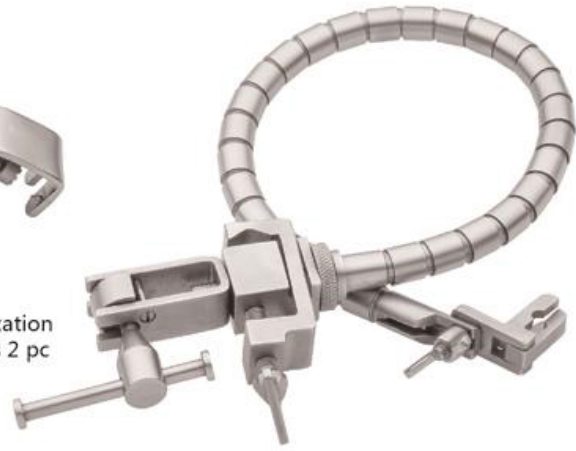

软轴牵开器  
flexible arm set  
ZF1836RN  
300, 快速锁紧型  
转接器固定式



软轴牵开器  
flexible arm  
complete set  
ZF270R  
350x9



软轴牵开器  
flexible arm set  
flexible arm 2pcs  
ZF276RN  
450, 杠杆式



(锥度式软轴牵开器) 软轴  
flexible arm set  
ZF277RN



杠杆式软轴牵开器  
flexible arm set,lever type  
ZF278RN  
450x9.5 ( ZF276RN,ZF271RN,ZF272RN ) (套)



软轴牵开器  
flexible arm,complete set  
ZF1838RN  
300, 带锁紧器



头架转接器  
connector between head  
resting system and flexible arms  
ZF998RN  
II型



头架转接器  
connector between head  
resting system and flexible arms  
ZF1844RN  
III型, 带单臂、双臂、J形臂固定器



头架转接器  
connector between  
head resting system  
and flexible arms  
ZF995RN



头架转接器  
connector between head  
resting system and flexible arms  
ZF1843RN  
连杆连接型



头架J形臂  
J shaped arm  
ZF988RN  
JB-I型, 250  
ZF1845RN  
JB-II型, 300



颅脑手术头架  
head resting system type TJ-II  
**ZF991R**  
TJ-II型



颅脑手术头架  
head resting system type TJ-III  
**ZF993RN**  
TJ-III型



颅脑手术头架  
head resting system type TJ-III  
**ZF992R**  
TJ-III型



颅脑手术头架  
head resting system type TJ-III  
**ZF1842RN**  
TJ-III多功能型



Neuro Instruments  
神经外科



Neuro Instruments  
神经外科



头圈牵开系统  
head self-dessecting system  
**ZF996RN**  
320



弧形悬杆式床架软轴固定器  
leyla retractor system type RZG-I  
**ZF997RN**  
RZG-I型